

Zirkonzahn®

VARIETY OF IMPLANT-PROSTHETICS COMPONENTS

Everything From A Single Source



WE ASSUME THE RESPONSIBILITY

UP TO 30-YEAR WARRANTY ON IMPLANT ABUTMENTS AND IMPLANTS

As one of the world's largest manufacturers, for the production of our implant-prosthetics components we use a high-quality medical titanium alloy (Ti-6Al-4V ELI according to ASTM F136 and ISO 5832-3) and meet the strictest quality criteria (ISO 13485 MDSAP; Medical Device Directive 93/42/EEC; EU Regulation 2017/745 on medical devices).

We assume the responsibility for our products granting voluntarily – in addition to the legally prescribed warranty obligation – up to 30 years of warranty on all Zirkonzahn implant abutments used (titanium bases, Multi Unit Abutments, Multi Unit Abutments Angled, Raw-Abutments® as well as the corresponding screws). Within the current Zirkonzahn warranty regulation, we explicitly include also implants from other manufacturers used with Zirkonzahn implant abutments.



Enrico and Julian Steger

The Zirkonzahn warranty regulation can be viewed at www.zirkonzahn.com.



View the production sites
Zirkonzahn Molaris I and II



PRODUCTION HALL 2



PRODUCTION HALL 3

EVERYTHING FROM A SINGLE SOURCE

We never surrender the control of our products to others. All implant components are designed and produced in South Tyrol at our production sites, Zirkonzahn Molaris I and II. Being the sole manufacture owners, we have full control on the complete production. We know our materials and we can ensure they form a perfect match. This is the only way we can take full responsibility for our products and ensure the highest quality.

In Zirkonzahn Molaris I and II we have a versatile pro CNC machinery with turning, grinding and coating systems. Here, highly accurate techniques are used to produce our milling tools, implant abutments (titanium bases, Raw-Abutments® etc.) and machine parts.

We are experts in our field and it is important that everyone shares their know-how. This is the only way to reach the best results.

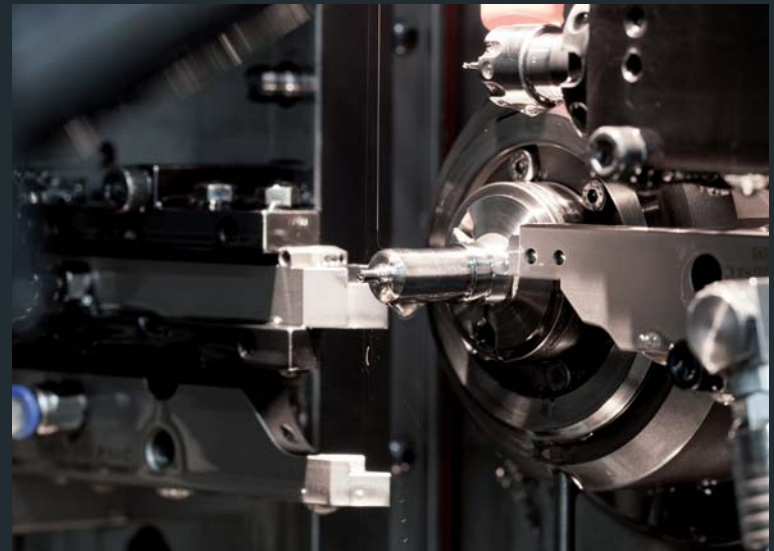



Mahr GmbH, 33091 Viersen, Germany
Kontakt: Mahr-Store, 1088, 33091 Viersen, Germany
Tel: +49 2120 2200, Fax: +49 2120 2200
E-Mail: mahr@mahrgroup.com, www.mahr.com

Mahr
TOL
MAX/MIN
SET TOL
ON/OFF
mm/inch

30
-0+
0.00
0.004
TOL
30

PRESET
SET
DATA
RESET
ABS.

MarCator 1088

EVERYTHING UNDER ONE ROOF

Especially when manufacturing implant restorations it is important to optimally adjust components to one another. From the implant planning software, to analogues for acquiring already placed implants, through titanium bases, Multi Unit Abutments or blanks with a pre-milled implant connection, we produce and develop everything on our own. All components are available for all common implant systems and are fully integrated in our Zirkonzahn.Software. With the Zirkonzahn Library Download Center, also 3Shape and exocad® users can implement the libraries into their design software.



More information



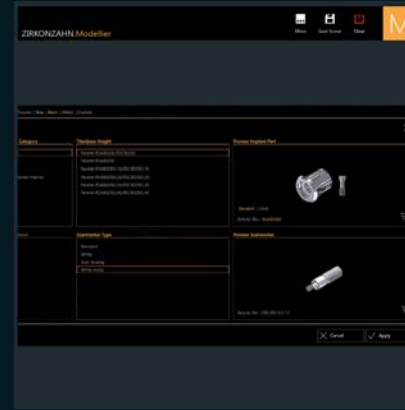

1

QUALITY

EVERYTHING FROM A SINGLE SOURCE

All implant prosthetics components are designed and produced at our production sites in South Tyrol.

STRICTEST QUALITY CRITERIA

In the manufacture of our components, we meet the strictest quality criteria (ISO 13485 MDSAP; Medical Device Directive 93/42/EEC; EU Regulation 2017/745 on medical devices).

100%

FULL COMPONENTS INTEGRATION

All components are fully integrated in our Zirkonzahn Software. In addition, with the Zirkonzahn Library Download Center, also 3Shape and exocad® users can implement the libraries into their design software.

24–48 h

FAST DELIVERY TO YOUR LABORATORY

Depending on the country, ordered components will be delivered directly to your laboratory within 24–48 hours.



View warranty regulation



30 YEARS

UP TO 30-YEAR WARRANTY

We provide up to 30 years of warranty on all Zirkozahn implant abutments used, as well as on implants of other manufacturers used with the Zirkozahn implant abutments.

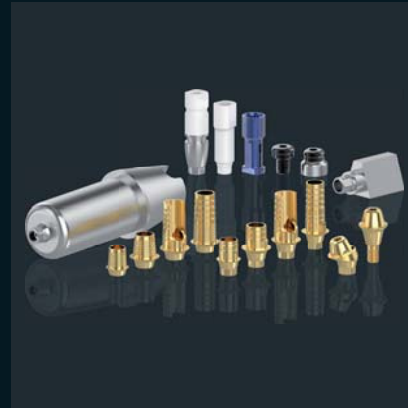

5000+

MORE THAN 5000 COMPONENTS

Adjusting each components to one another is particularly important especially in case of implant-supported restorations, for this reason we provide a wide range of implant prosthetics components.

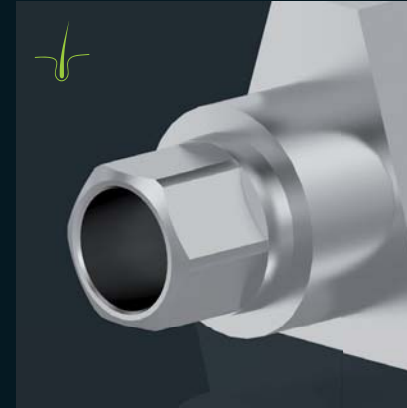

µm

WITH THE PRECISION OF 1/10 – 1/100 OF A HAIR

All components are produced according to the high standards we set for our production process. In order to meet our search for precision and perfection, we use the latest manufacturing technologies.



140+

FOR THE MOST COMMON IMPLANT SYSTEMS

Our components are available for more than 140 implant systems and our libraries are constantly expanded.

AVAILABLE COMPONENTS FOR YOUR RESTORATIONS

LABORATORY ANALOGUE

PAGE 20

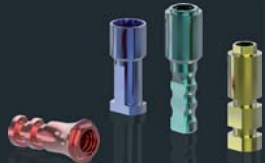

HEALING CAP

PAGE 21



SCANANALOG

PAGE 22



SCANANMARKER

SEITE 23



WHITE SCANMARKER

PAGE 24



WHITE METAL SCANMARKER

PAGE 25



IMPRESSION COPING

PAGE 26



CONICAL TITANIUM BASE NON HEX

PAGE 34



PARALLEL TITANIUM BASE HEX

PAGE 35



NARROW TITANIUM BASE NON HEX

PAGE 36



NARROW TITANIUM BASE HEX

PAGE 37



TITANIUM BASE NON HEX K80
ANGLED SCREW CHANNEL (ASC)

PAGE 40



TITANIUM BASE HEX K80 ANGLED
SCREW CHANNEL (ASC)

PAGE 41



CONICAL TITANIUM BASE NON
HEX K85

PAGE 44



PARALLEL TITANIUM BASE HEX
K85

PAGE 45

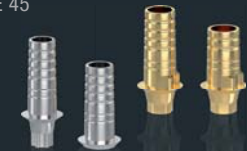

ABUTMENT SCREW METAL

PAGE 48



ABUTMENT SCREW ZIRCONIA

PAGE 49



ZIRKONZAHN MULTI UNIT
ABUTMENT NON HEX

PAGE 52



ZIRKONZAHN MULTI UNIT
ABUTMENT 17°

PAGE 53



LOC-CONNECTOR

PAGE 60



RAW-ABUTMENT® HEX

PAGE 62

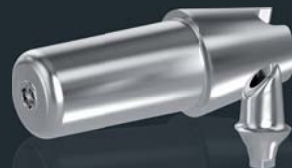

ZIRKONZAHN TITANIUM POST

PAGE 64



TOOLS

PAGE 66



IMPLANT ABUTMENTS

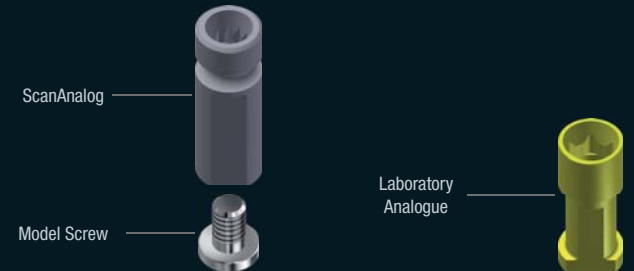
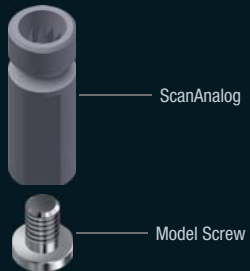
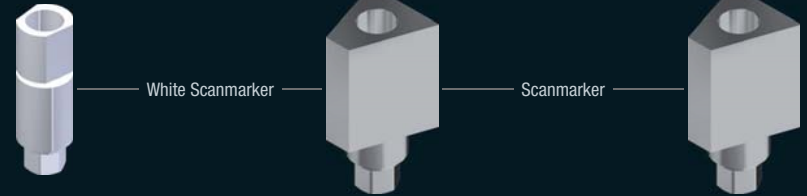

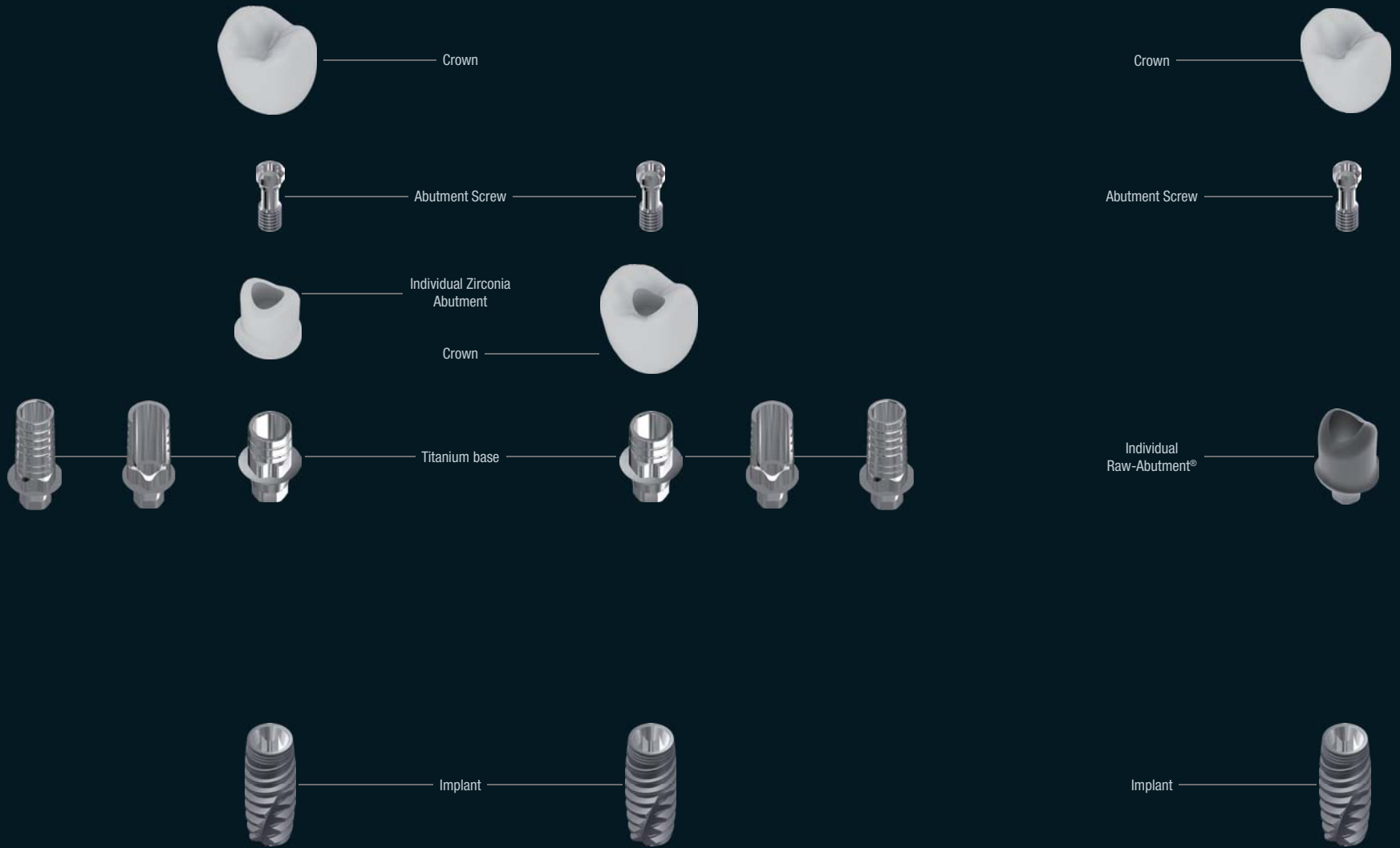

MULTI UNIT ABUTMENTS

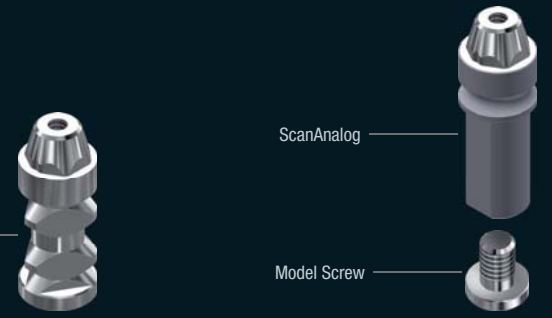
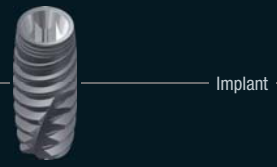
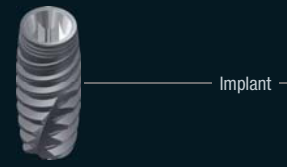
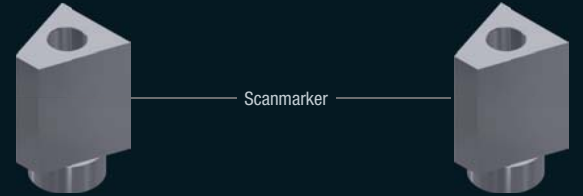
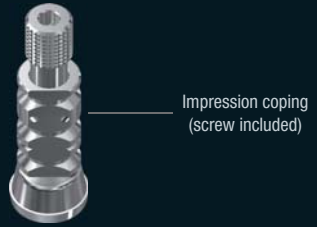

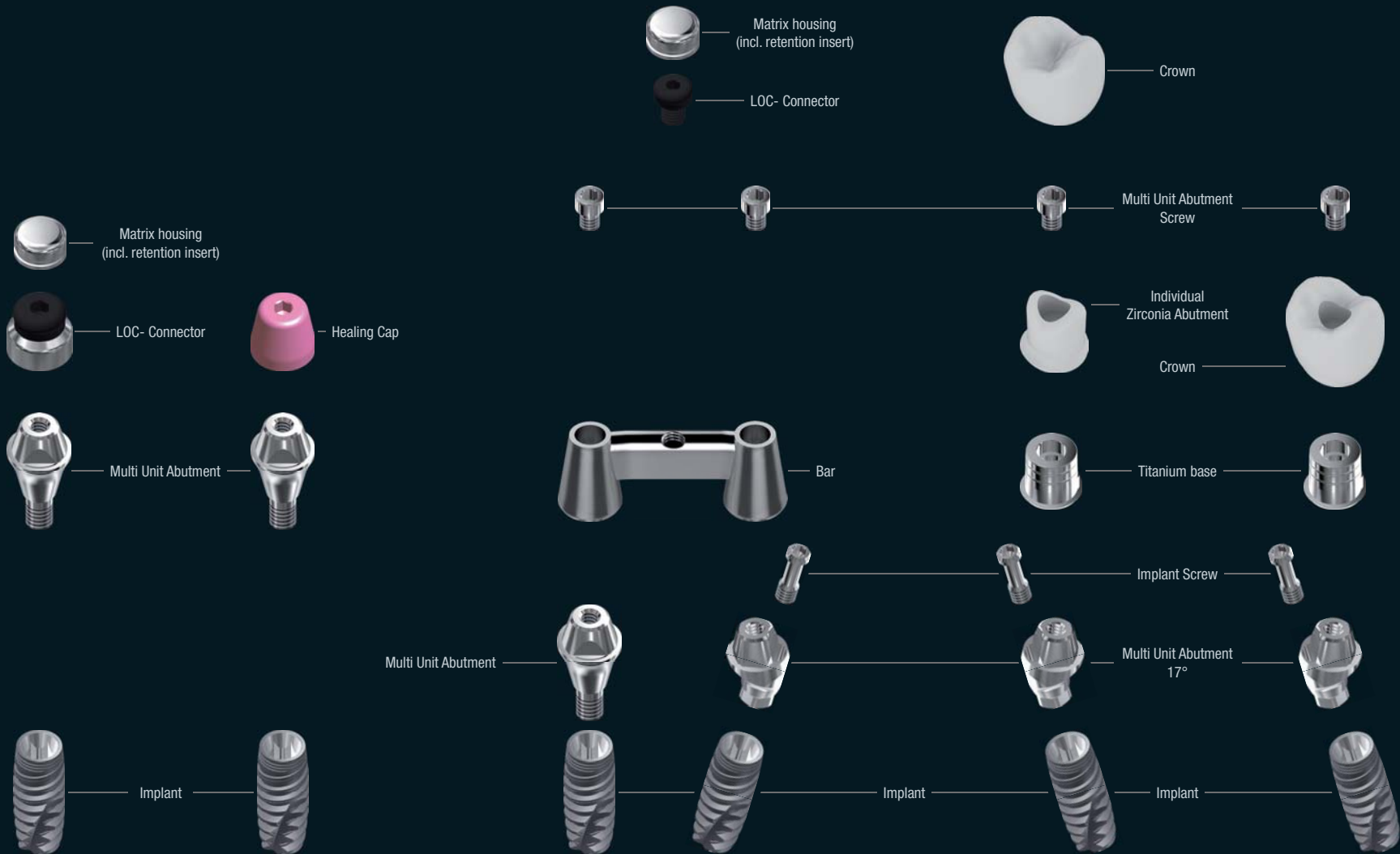

ABUTMENTS FOR ALL COMMON IMPLANT SYSTEMS

The system library is constantly expanded. An overview of all systems stored in the software and information regarding the torques are available at www.zirkonzahn.com/implant-systems or by telephone (+39 0474 066 680).

| | | | | | | | | |
|---|---|---------------------------------------|------------------------------------|--|--|---|---|--|
| Zirkonzahn Multi Unit Abutments (ZZ MUA) | A.B. Dental | Advan GTB | Alpha-Bio Tec® SPI/DFI/ATID | Alpha-Bio Tec® Conical Hex Connection Implants | Anthogyr® Axiom® | Argon K3Pro® Mini Konus / Standard | ASTRA TECH Implant System EV | ASTRA TECH Implant System EV - UniAbutment® EV |
| ASTRA TECH Implant System EV - Profile | ASTRA TECH Implant System EV - MultiBase EV | ASTRA TECH Implant System OsseoSpeed™ | ASTRA TECH UniAbutment® | A-Z Implant® MC | A-Z Implant® VL | BEGO Semados® Mini | BEGO Semados® S/RI/SC/SCX/RS/RX-Line / MultiPlus System | BEGO Semados® Platform Switch Design SC/SCX/RS/RX-Line |
| BioComp® Dental BC | BioHorizons® External | BioHorizons® Internal | BioHorizons® Multi-unit Abutment | Biomet 3i™ Certain® Implant System | Biomet 3i™ External Connection Implant System (OSSEOTITE®) | Biomet 3i™ Low Profile Abutment | Biotech Dental KONTACT | BrainBase Corporation MYTIS Arrow Implant |
| Bredent SKY® Classic / blueSKY | Bredent SKY® fast & fixed | Bredent SKY® uni.cone | Bredent SKY® copaSKY | BTI® Conical Spacer | BTI® Externa® | BTI® Interna® | BTI® Multi-Im® | BTI® Multi-Im® Angled® |
| BTI® Tiny® | btk the smile system® – BT-Klassik | btk the smile system® – BT-Konic | btk the smile system® – BT-Isykone | btk the smile system® – BT-Safe | CAMLOG® Bar Abutments (COMFOUR®) | CAMLOG® CERALOG® | CAMLOG® CONELOG® | CAMLOG® J-Line/K-Line |
| CAMLOG® VARIO SR | Champions® Implants (R) Evolution | Conmet® Hex | Connect® | Cowellmedi INNO Internal Implant System™ | Cumdente | Dentalpoint AG Zeramex® P6 | Dentalpoint AG Zeramex® XT | Dental Ratio® OKTAGON® Bone Level |
| Dental Ratio® OKTAGON® Multi Units Abutment | Dental Ratio® OKTAGON® Tissue Level | DentalTech ImpLassic® | DentalTech ImpLassic®/ Implogic® | Dentium Implantium / SuperLine | Dentium Screw Abutment | Dentsply Sirona® Ankylos® (Friadent) / Balance Base Abutment Narrow | Dentsply Sirona® XiVE® MP/TG | Dentsply Sirona® XiVE®/Frialit |

Buy components of the available systems online



| | | | | | | | | |
|--|--|-------------------------------------|---------------------------------|-------------------------------------|--|--|--|---|
| Dyna Dental® Octalock/Helix | FairImplant FairTwo™ | GC Tech. Aadva™ | Global D Tekka® In-Kone® | Global D twinKon® | Implant Direct™ Legacy™ | Implant Direct™ Overdenture Abutment | Intra-Lock® International Conic Abutment System | Intra-Lock® International FlatOne® |
| Intra-Lock® International Internal Implants | Intra-Lock® International UniHex™ | Klockner® Essential® Cone | Klockner® NK2/SK2 | LASAK® BioniQ® | MEDENTIKA® MedentiBASE® | MEDENTIKA® M-Implant/ Microcone | Medentis medical ICX®-templant | Medentis medical ICX-multi®-Konzept |
| Medical Instinct® BoneTrust® plus I hex | Megagen AnyOne® | Megagen AnyRidge® | Megagen ExFeel® External | Megagen ExFeel® Internal | Megagen MiNi™ | MIS® C1 | MIS® Multi Unit Abutment | MIS® Multi Unit System |
| MIS® SEVEN | MIS® V3 | Mozo-Grau® Ticare® Tapered Screw® | Neobiotech IS | Neoss® ProActive® | Nobel Biocare® Brånemark System® MkIII/Shorty/Groovy® / NobelSpeedy Shorty/Groovy® | Nobel Biocare® Multi-unit Abutment | Nobel Biocare® NobelActive®/ NobelReplace® CC/ Nobel Parallel CC | Nobel Biocare® NobelReplace®/ Replace Select Tapered/NobelSpeedy® |
| Nobel Biocare® NobelZygoma (Brånemark System®) | Nobel Biocare® On1™ | OSSTEM Implant Convertible Abutment | OSSTEM Implant GS/TS | OSSTEM Implant GS/TS Multi Abutment | OSSTEM Implant US | Paltop® Conical Active | Paltop® Internal HEX Connection | Paltop® Multi-Unit Abutment |
| Paltop® Single-Unit Abutment | PHIBO® TSA® Advance | PHIBO® TSH® | SGS Dental Conical Platform | SGS Dental Internal Hexagon | SGS Dental The-One multi-unit abutments | SIC® invent SICace® | SIC® invent SICvantage® | Southern Implants® Deep Conical |
| Southern Implants® External Hex | Southern Implants® Internal Hex | Southern Implants® IT Connection | Straumann® Bone Level® | Straumann® Multibase Abutment | Straumann® Screw-Retained Abutment | Straumann® Tissue Level (Standard Plus Narrow Neck CrossFit® SynOcta®) | Straumann® BLX | Sweden & Martina CSR |
| Sweden & Martina Outlink² | Sweden & Martina P.A.D® Multi Unit Abutment | Sweden & Martina Prama | Sweden & Martina Premium Kohno® | Variobase® for crown | Thommen Medical SPI® | Thommen Medical SPI® VARIOmulti | Warantec Oneplant | Zimmer Dental® Eztetic™ Implant System |
| Zimmer Dental® Tapered Screw-Vent® | Zimmer Dental® Tapered Screw-Vent® Multi Unit Abutment | | | | ... | | | |

CAPTURE
TITANIUM BASES
MIJAS
LOC-CONNECTORS
RAW-ABUTMENTS®
TITANIUM POSTS
ACCESSORIES
OVERVIEW
SOFTWARE

LABORATORY ANALOGUE

Our laboratory analogues are made of a medical titanium alloy and replicate the exact implant position and connection. In this way, it is possible to check the fitting accuracy of the final restoration with implant abutments directly on the model. To distinguish the different diameters, the analogues are also available pre-coloured.



HEALING CAP

Healing caps are used during the healing phase to seal the Zirkozahn Multi Unit Abutments and to define the emergence profile. They can be anodised in different colours or be available already anodised in pink.

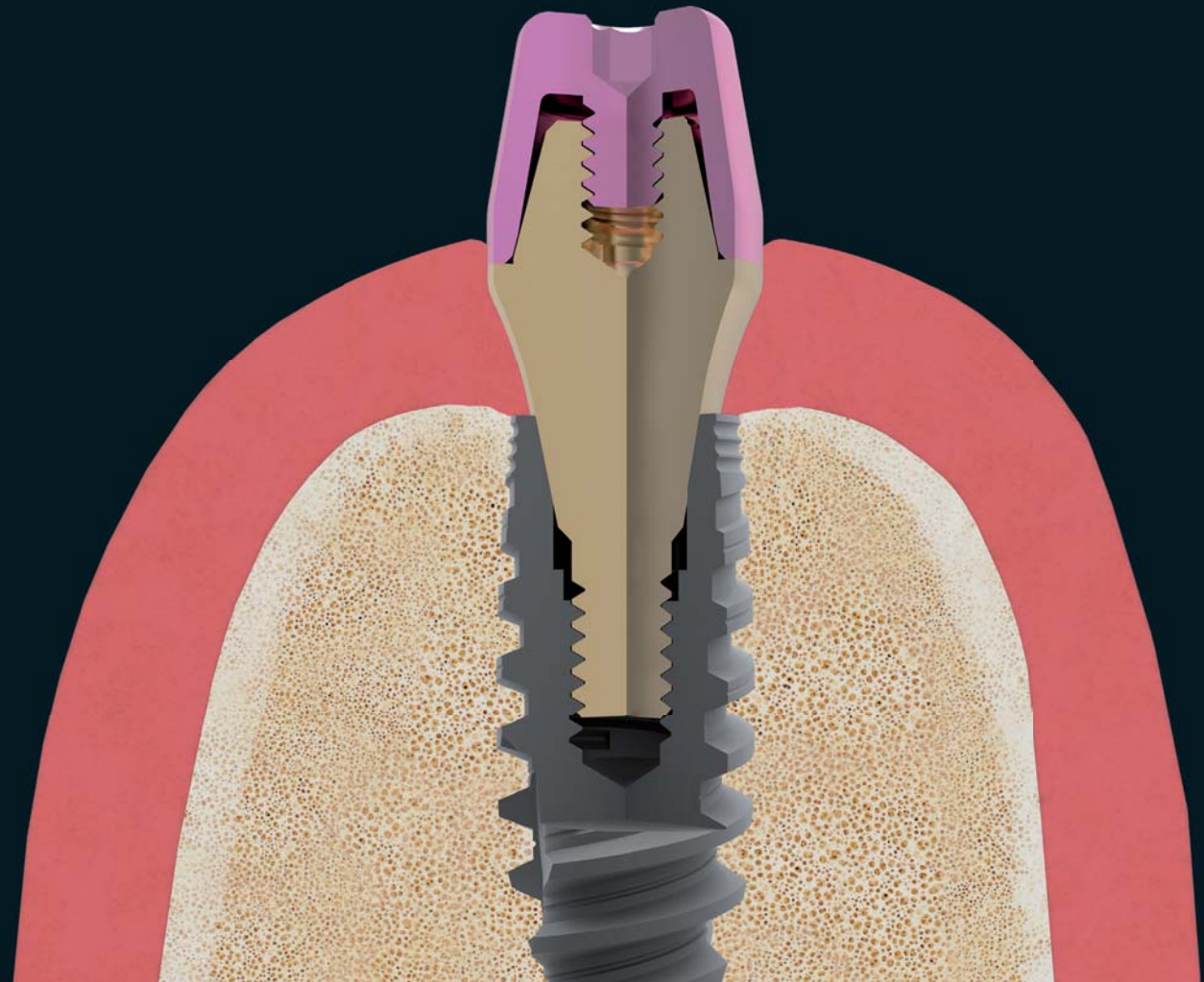

SCANANALOG

*ScanAnalog*s combine the function of a laboratory analogue with the one of a scanmarker. In contrast to conventional scanmarkers, they are scanned directly on the impression, not on the model. They are screwed into the impression copings and digitised with the Zirkonzahn scanner: the acquired implant position can be now directly transferred into the software without needing a plaster model. Physical models can be then produced from the acquired data (CAD/CAM Model Maker software module). In their role as laboratory analogues, *ScanAnalog*s replicate the exact implants position and orientation on the model.

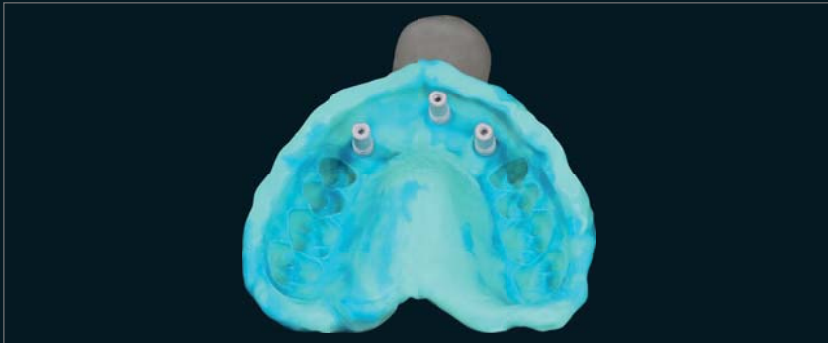

SCANMARKER

Thanks to the special geometry of the Scanmarkers and the precision of the Zirkonzahn scanners, it is possible to transfer the exact implants position and orientation from the model into the software.

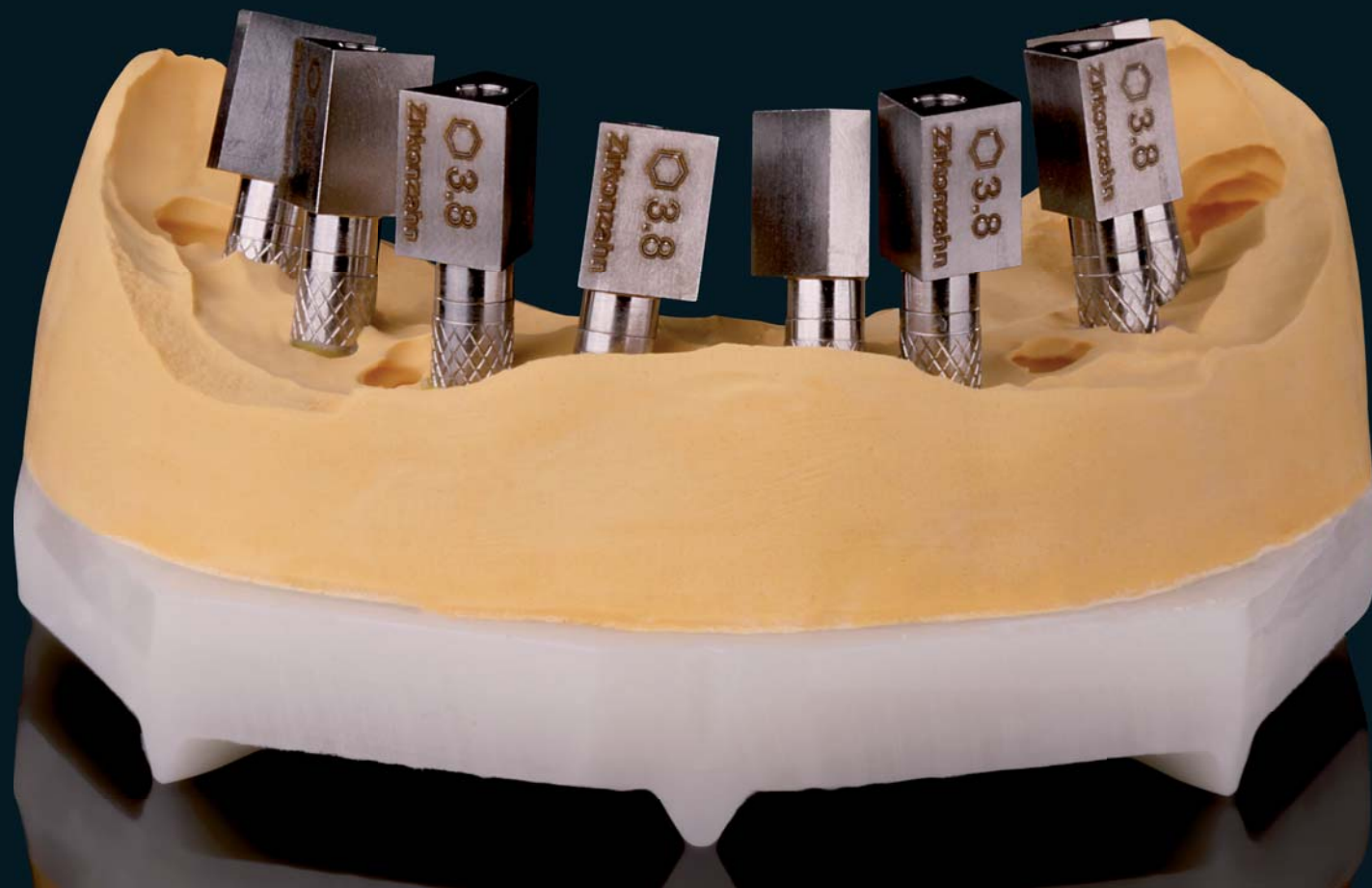

WHITE SCANMARKER

White Scanmarkers are used during the scan phase to register the implant position and orientation. The white surface of the scanbody is not reflective, therefore they are especially suitable for the application in the patient's mouth. Thanks to their small geometry, it is even possible to scan implants which are particularly narrow or deeply placed. White Scanmarkers can also be used as Scanmarkers on the plaster model.



WHITE METAL SCANMARKER

White Metal Scanmarkers are used to acquire the implants position and orientation during intraoral or model scans. After appropriate sterilisation, they can be reused several times. White Metal Scanmarkers are particularly resistant, dimensionally stable and visible on x-rays thanks to their plasma coating, which prevents light reflection during scanning (intra- and extra oral) improving scan quality. Regardless of the implant system used, all White Metal Scanmarkers can be screwed in and out with a special screwdriver (Screwdriver WMSM and Impression Coping). The screwdrivers are available in different lengths.

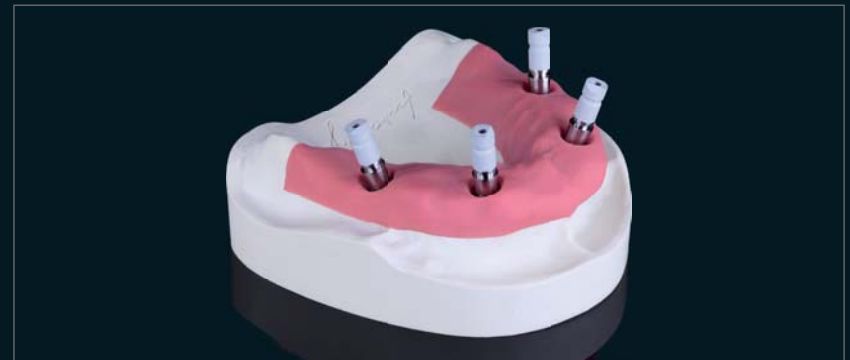
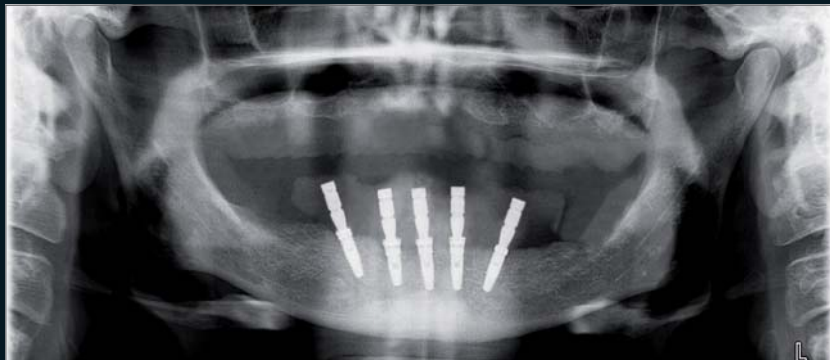
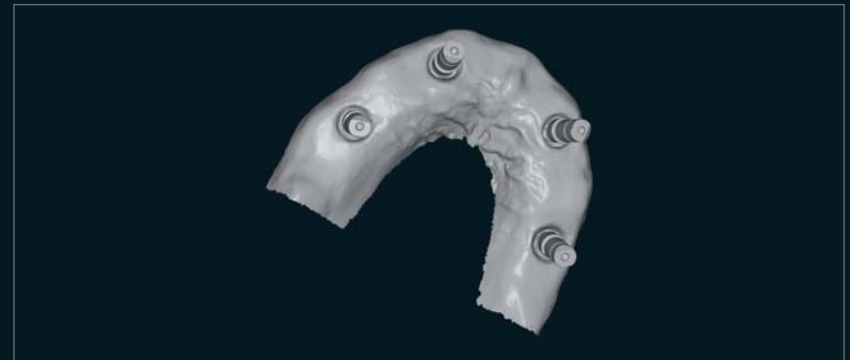

IMPRESSION COPING

Impression copings are used for the exact transfer of the implant position. This can be transferred to the model in two ways: using laboratory analogues or our ScanAnalog, creating a digital implant model without preparing a traditional plaster model.

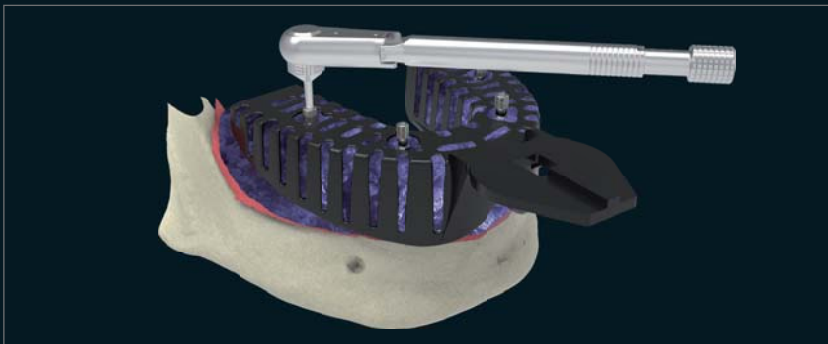
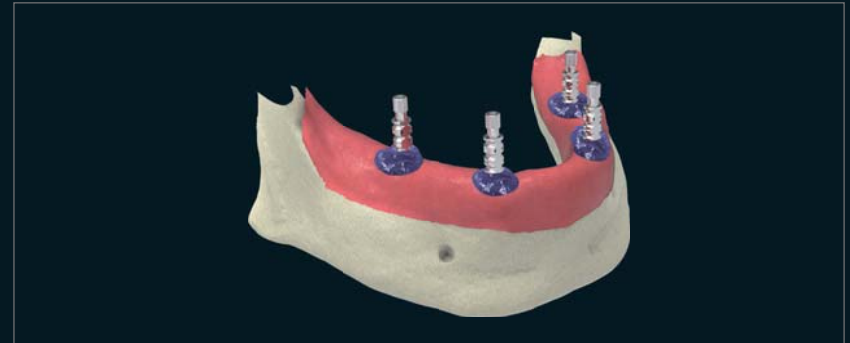
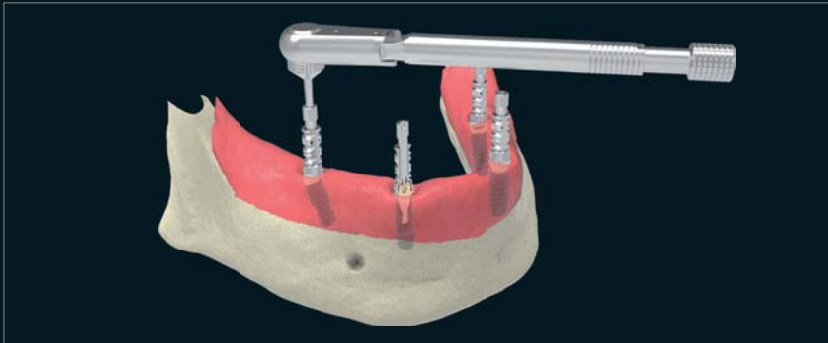

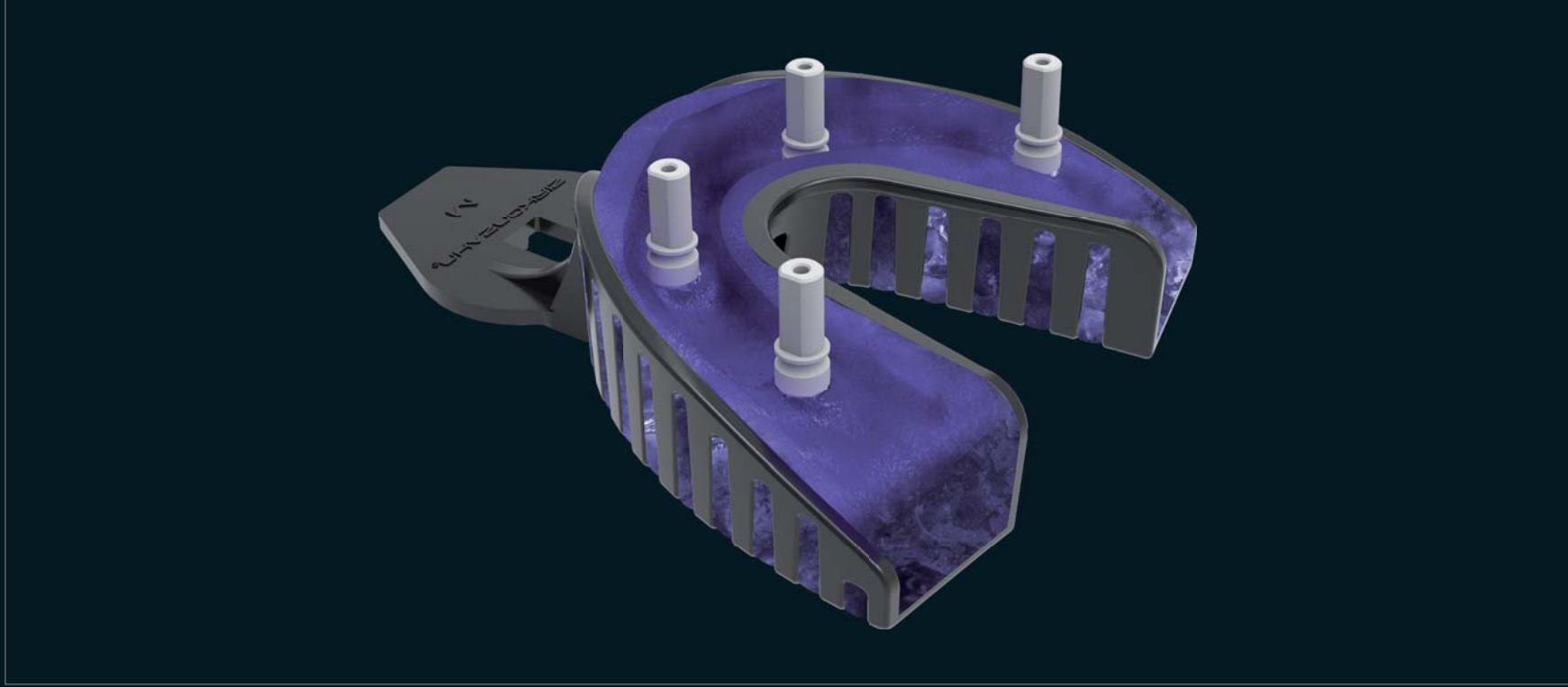

IMPRESSION TAKING WITH OPEN/CLOSED TRAYS AND IMPRESSION COPINGS

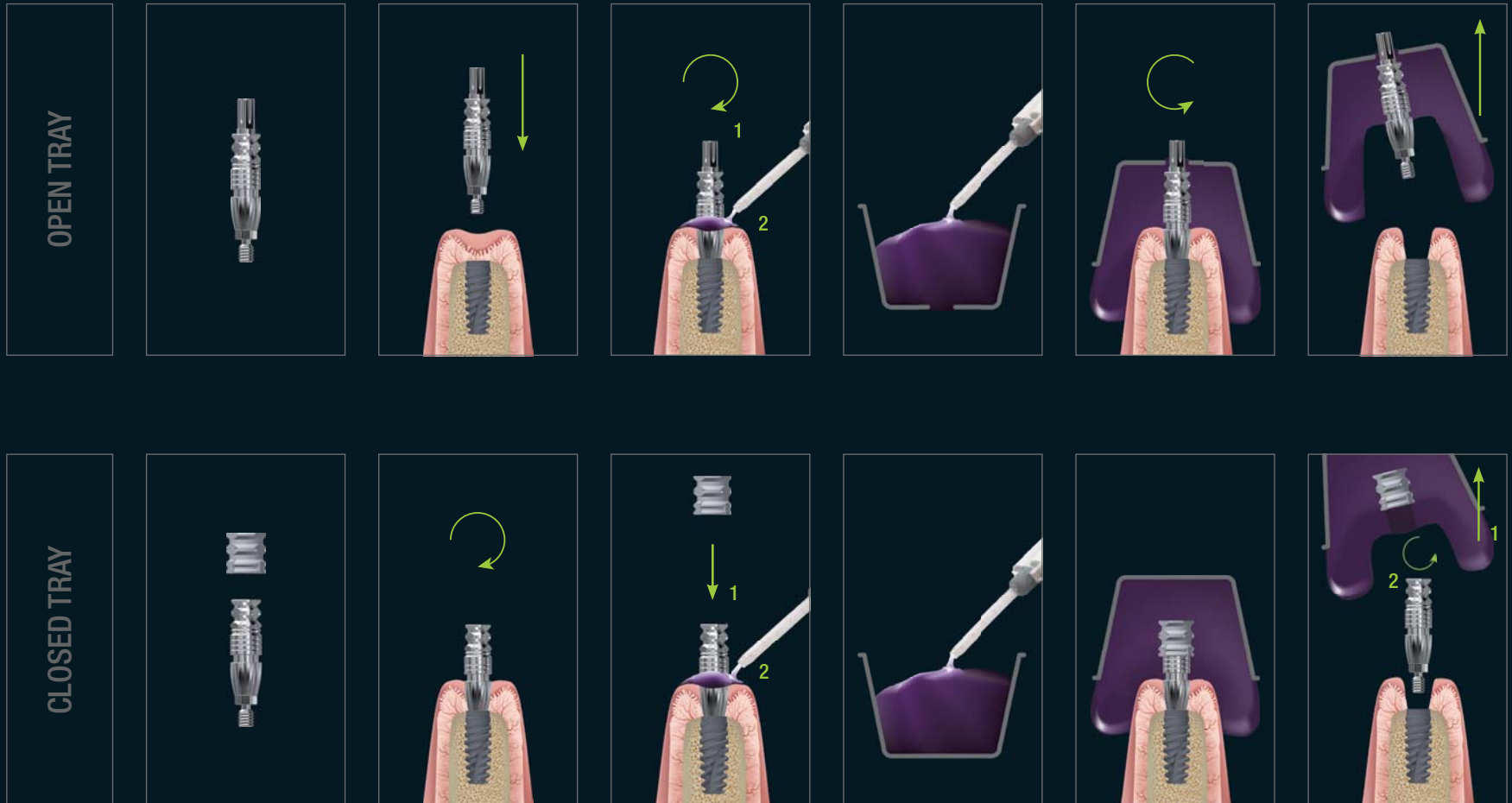

LABORATORY ANALOGUE

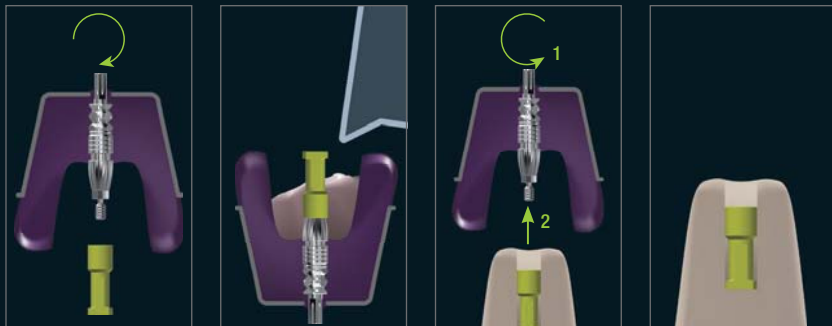

SCANANALOG

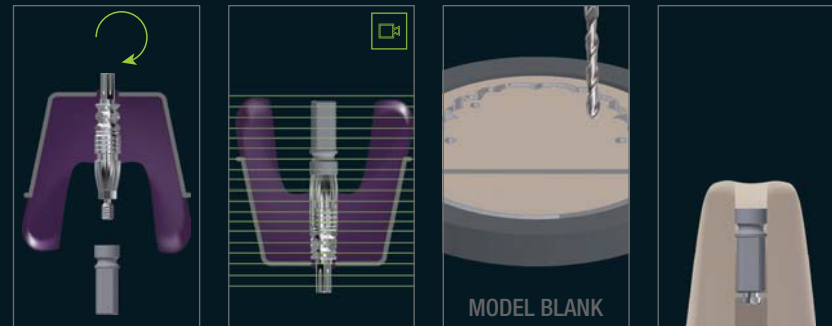

LABORATORY ANALOGUE

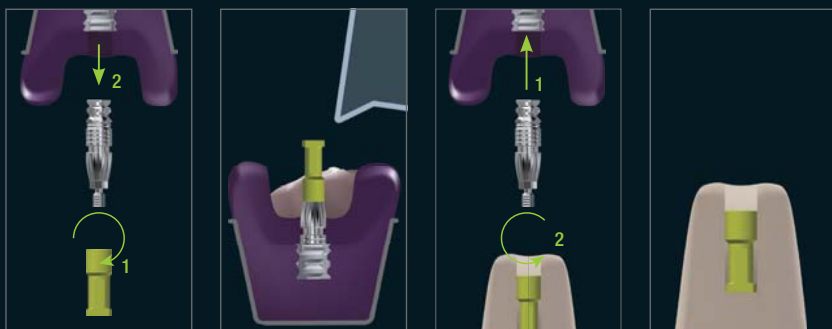

SCANANALOG

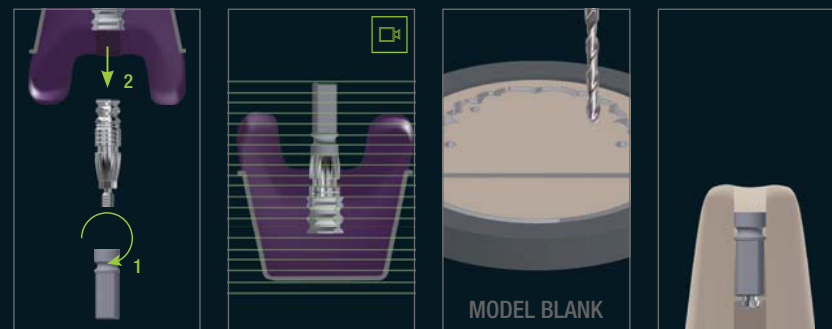

TITANIUM BASES

Unlike restorations that are directly screwed on the implant, the use of titanium bases reduces the effect of transverse forces on the prosthesis. We generally recommend the use of titanium bases for all implant-supported restorations, especially for those in the anterior region.

TITANIUM BASES IN 5 HEIGHTS ...

Except for the Narrow Titanium bases, Zirkonzahn titanium bases are available in up to five different platforms or chimney heights, in order to either bring the implants to the desired gingival level or to adjust them to the tooth length. Due to their reduced geometry, the Narrow Titanium Bases are used in the anterior region.

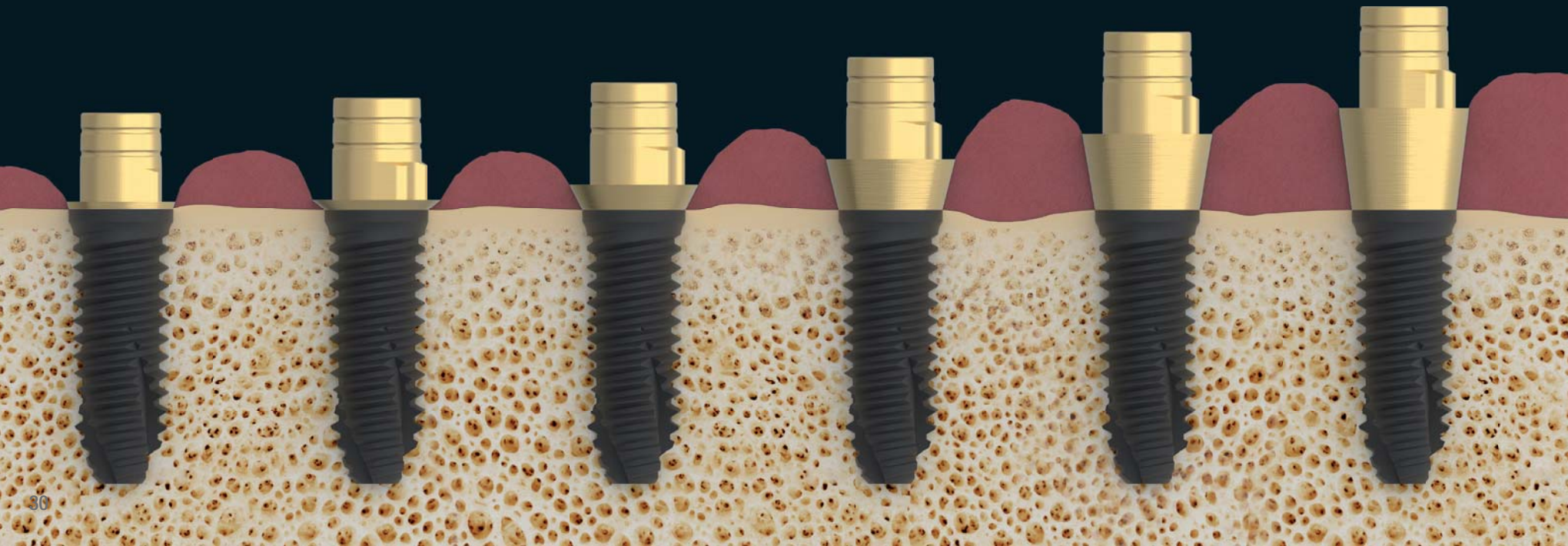



... GOLD-PLATED AND ANODISED

All Zirkonzahn titanium bases are available with a high quality gold plating. The gold coating increases the biocompatibility and the golden shade reduces the grey value of the entire restoration.

Alternatively, titanium bases can also be anodised in different colours using the Titanium spectral-coloring Anodizer. The high biocompatibility of the material remains unchanged.



SINGLE CROWNS

IMPLANT ABUTMENTS TO USE

PARALLEL TITANIUM BASE HEX

PAGE 35



NARROW TITANIUM BASE HEX

PAGE 37



TITANIUM BASE HEX K80 ANGLED
SCREW CHANNEL (ASC)

PAGE 41



PARALLEL TITANIUM BASE HEX
K85

PAGE 45

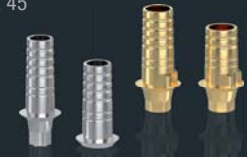

ZIRKONZAHN MULTI UNIT
ABUTMENT 17°

PAGE 53



RAW-ABUTMENT® HEX

PAGE 62

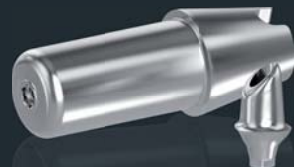

MULTI-UNIT BRIDGES

IMPLANT ABUTMENTS TO USE

CONICAL TITANIUM BASE
NON HEX

PAGE 34



NARROW TITANIUM BASE
NON HEX

PAGE 36



TITANIUM BASE NON HEX K80
ANGLED SCREW CHANNEL (ASC)

PAGE 40



CONICAL TITANIUM BASE
NON HEX K85

PAGE 44



ZIRKONZAHN MULTI UNIT
ABUTMENT NON HEX

PAGE 52



ZIRKONZAHN MULTI UNIT
ABUTMENT 17°

PAGE 53



RAW-ABUTMENT® HEX

PAGE 62

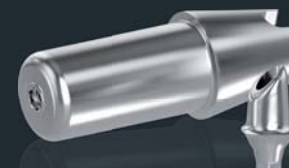

CONICAL TITANIUM BASE NON HEX

Conical Titanium Bases NON HEX without anti-rotation connection as well as anti-rotation device on the chimney, are ideal for the manufacturing of bridges and multi-unit restorations. The titanium bases are designed as short and conical as possible. The spiral grooves on the surface increase the contact area and ensure optimal cement adhesion.



For multi-unit restorations



Conical chimney with spiral grooves



Also available gold-plated for increased biocompatibility and reduced grey values



Without anti-rotation connection as well as anti-rotation device on the chimney



Available in different gingival heights



PARALLEL TITANIUM BASE HEX

Depending on the implant system, Parallel Titanium Bases HEX are equipped with the required anti-rotation connection as well as anti-rotation device on the chimney. This ensures that restorations can no longer be twisted once they are cemented. They are suitable for single crowns.



For single crowns



Parallel chimney



Also available gold-plated for increased biocompatibility and reduced grey values



With anti-rotation connection as well as anti-rotation device on the chimney



Available in different gingival heights



NARROW TITANIUM BASE NON HEX

Thanks to their reduced geometry, Narrow Titanium Bases NON HEX without anti-rotation connection as well as anti-rotation device on the chimney, are perfectly suitable for multi-unit restorations on implants placed very closely. The spiral grooves on the surface increase the contact area and ensure optimal cement adhesion.



For multi-unit restorations



Conical chimney with spiral grooves

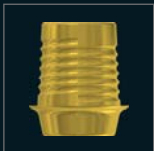

Also available gold-plated for increased biocompatibility and reduced grey values



Without anti-rotation connection as well as anti-rotation device on the chimney



NARROW TITANIUM BASE HEX

Depending on the implant system, Narrow Titanium Bases HEX are equipped with the required anti-rotation connection as well as anti-rotation device on the chimney. This ensures that restorations can no longer be twisted once they are cemented. Thanks to their reduced geometry, they are suitable for single crowns closely placed in the anterior region.



For single crowns



Parallel chimney



Also available gold-plated for increased biocompatibility and reduced grey values



With anti-rotation connection as well as anti-rotation device on the chimney



PARALLEL TITANIUM BASE HEX

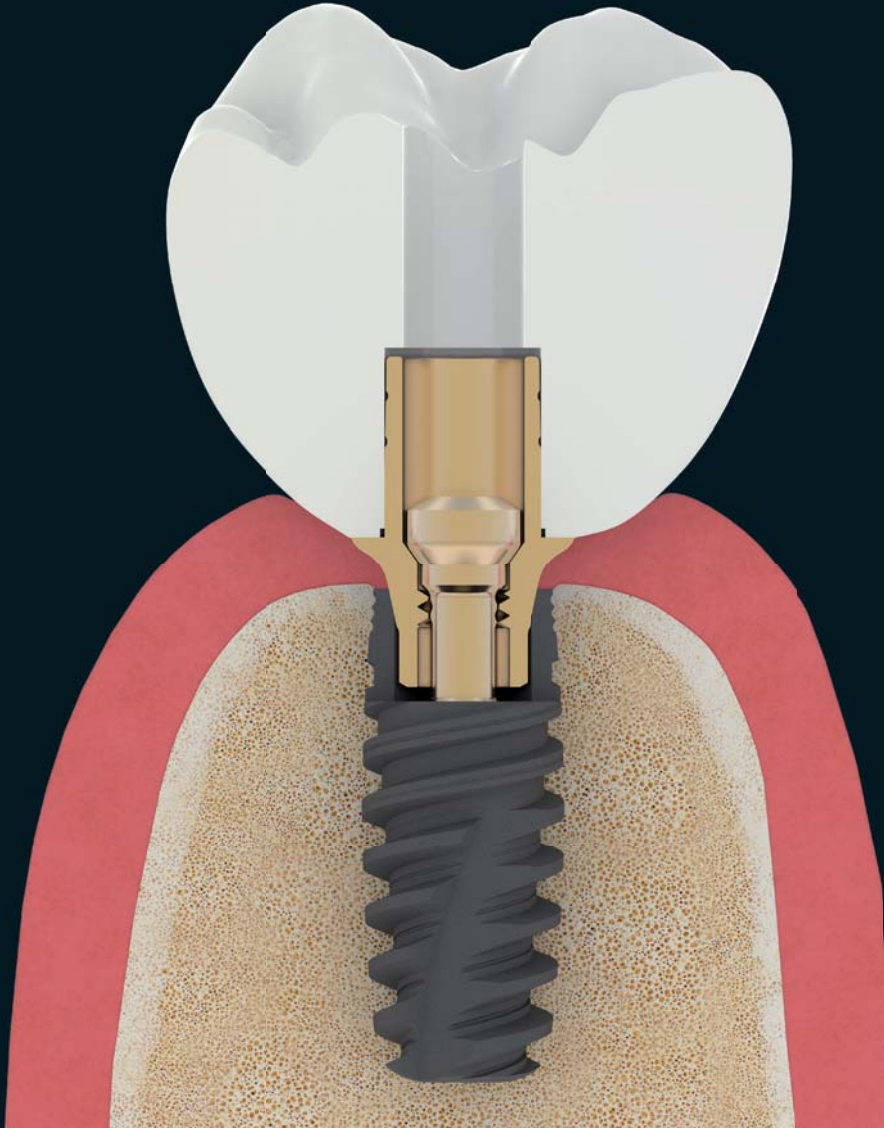

NARROW TITANIUM BASE HEX

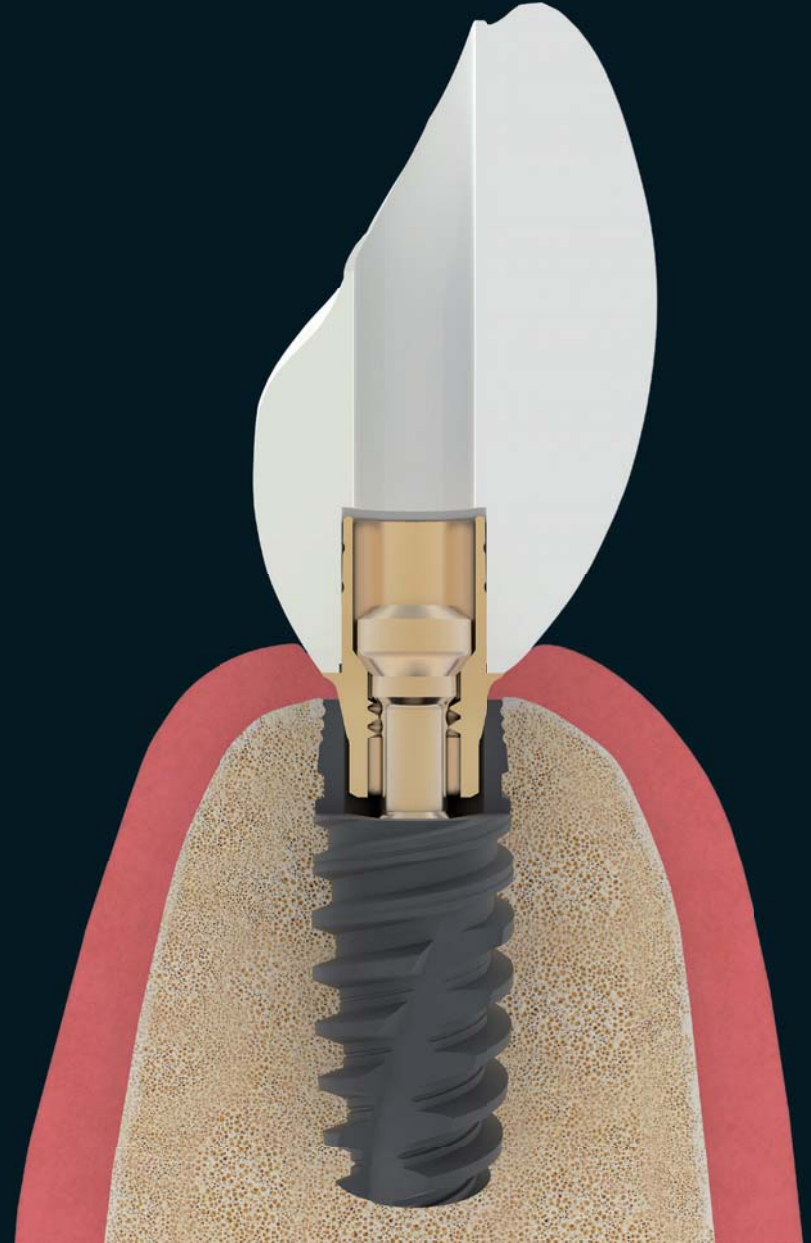

NARROW TITANIUM BASE

Narrow Titanium Bases are especially advantageous for implants on bone level, since their platform diameter is minimised. This helps to prevent bone atrophy. Thanks to their reduced platform height, their metal structure is invisible under the restoration, even in case of very low gingival level or gingival atrophy. They are suitable for closely placed implants in the anterior region.



TITANIUM BASE NON HEX K80 ANGLED SCREW CHANNEL (ASC)

The Titanium Bases NON HEX K80 Angled Screw Channel without anti-rotation connection, but with the anti-rotation device on the chimney, are ideal for the manufacturing of bridges and multi-unit restorations. These titanium bases are provided with cut-off marks, which are useful to adjust the height and, at the same time, increase the contact area, ensuring optimal cement adhesion.



For multi-unit restorations



Without anti-rotation connection, but with anti-rotation device as well as cut-off marks on the chimney for adjusting the height



Also available gold-plated for increased biocompatibility and reduced grey values



The side opening permits the tilting of the screw access channel from 0° to 30°



Chimney height can be adjusted to tooth length



TITANIUM BASE HEX K80 ANGLED SCREW CHANNEL (ASC)

Depending on the implant system, Titanium Bases HEX K80 ASC are equipped with the required anti-rotation connection as well as anti-rotation device on the chimney. This ensures that restorations can no longer be twisted once they are cemented. They are suitable for single crowns. These titanium bases are provided with cut-off marks, which are useful to adjust the height and, at the same time, increase the contact area, ensuring optimal cement adhesion.



For single crowns



With anti-rotation connection as well as cut-off marks on the chimney for adjusting the height



Also available gold-plated for increased biocompatibility and reduced grey values



The side opening permits the tilting of the screw access channel from 0° to 30°



Chimney height can be adjusted to tooth length



TITANIUM BASE K80 ANGLED SCREW CHANNEL (ASC)

Titanium Bases K80 Angled Screw Channel combine two advantages in one product. On the one hand, the adjustable chimney height ensures optimal stability and force distribution. On the other hand, the screw channel can be tilted up to 30° to compensate for non-optimal implant positions. The height of the titanium base can be individually adapted to the each restoration. Depending on the intended use, the titanium bases are available with or without anti-rotation device.

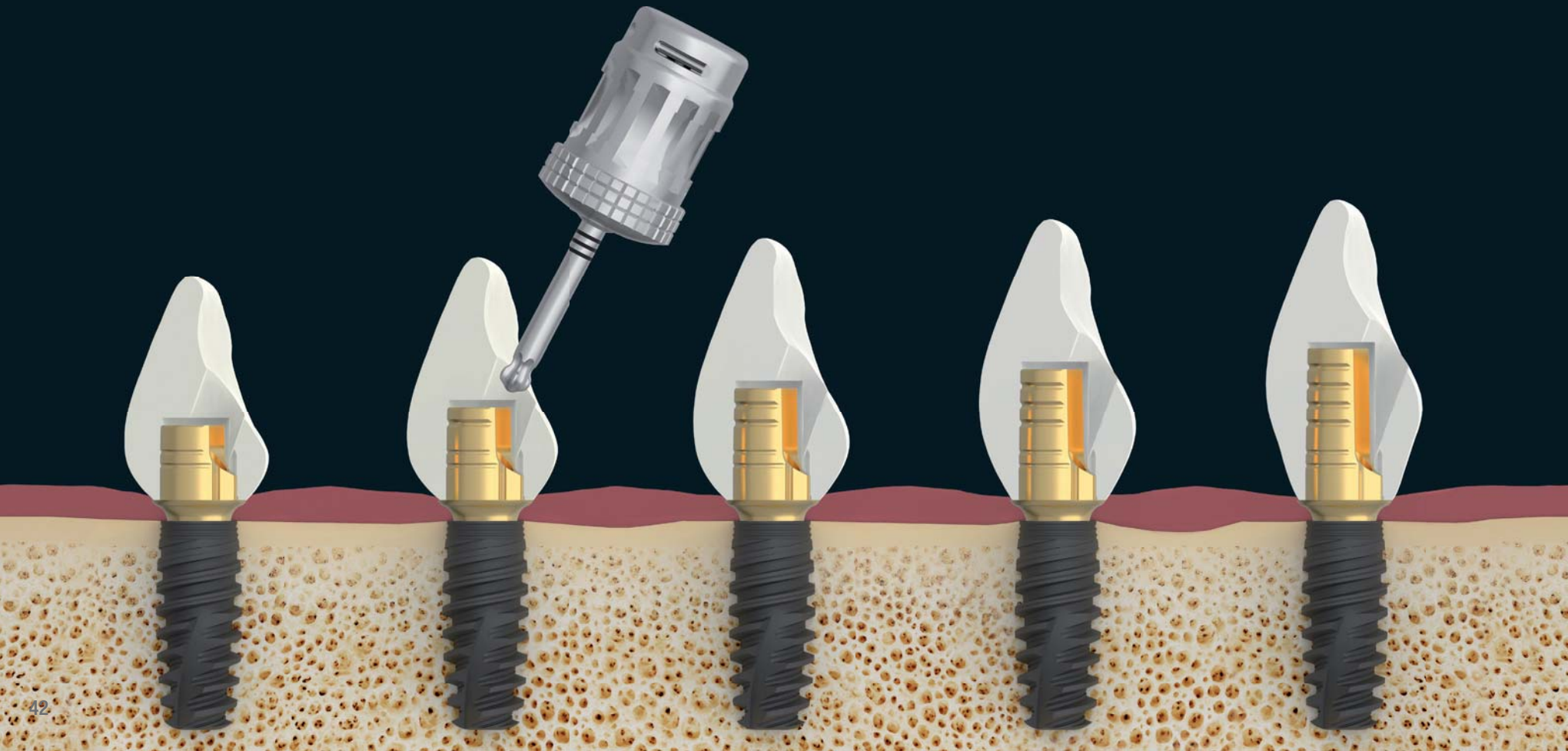

The tilted screw channel of the titanium bases K80 ASC prevents the vestibular protrusion of the screw channels, without compromising the full-arch aesthetics.



Conical Titanium Bases NON HEX

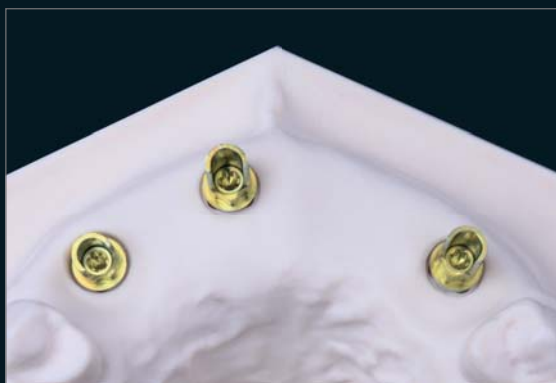

Titanium Base NON HEX K80 Angled Screw Channel (ASC)



CONICAL TITANIUM BASE NON HEX K85

The Conical Titanium Bases NON HEX K85 without anti-rotation connection as well as anti-rotation device on the chimney, are ideal for the production of bridges and multi-unit restorations. The spiral grooves on the surface increase the contact area and ensure an optimal cement adhesion.



For multi-unit restorations



Conical chimney with spiral grooves



Also available gold-plated for increased biocompatibility and reduced grey values



Without anti-rotation connection as well as anti-rotation device on the chimney



Chimney height can be adjusted to tooth length



PARALLEL TITANIUM BASE HEX K85

Depending on the implant system, Parallel Titanium Bases HEX K85 are equipped with the required anti-rotation connection as well as anti-rotation device on the chimney. This ensures that restorations can no longer be twisted once they are cemented. They are suitable for single crowns.



For single crowns



Parallel chimney



Also available gold-plated for increased biocompatibility and reduced grey values



With anti-rotation connection as well as anti-rotation device on the chimney



Chimney height can be adjusted to tooth length



TITANIUM BASE K85

The titanium bases K85 can be individually adapted to the restoration thanks to their adjustable chimney height. This ensures optimal force distribution and stabilises the whole structure. Depending on the intended use, the titanium bases are available with or without anti-rotation device.

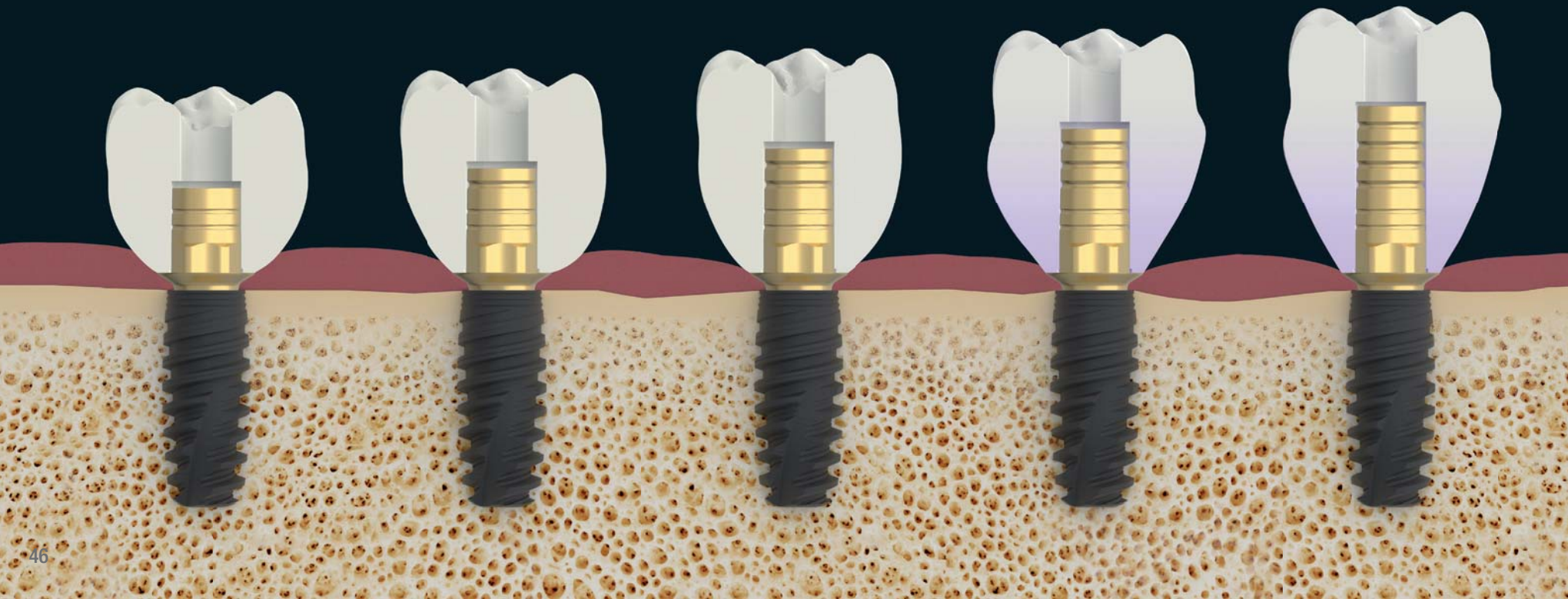

Read the instructions

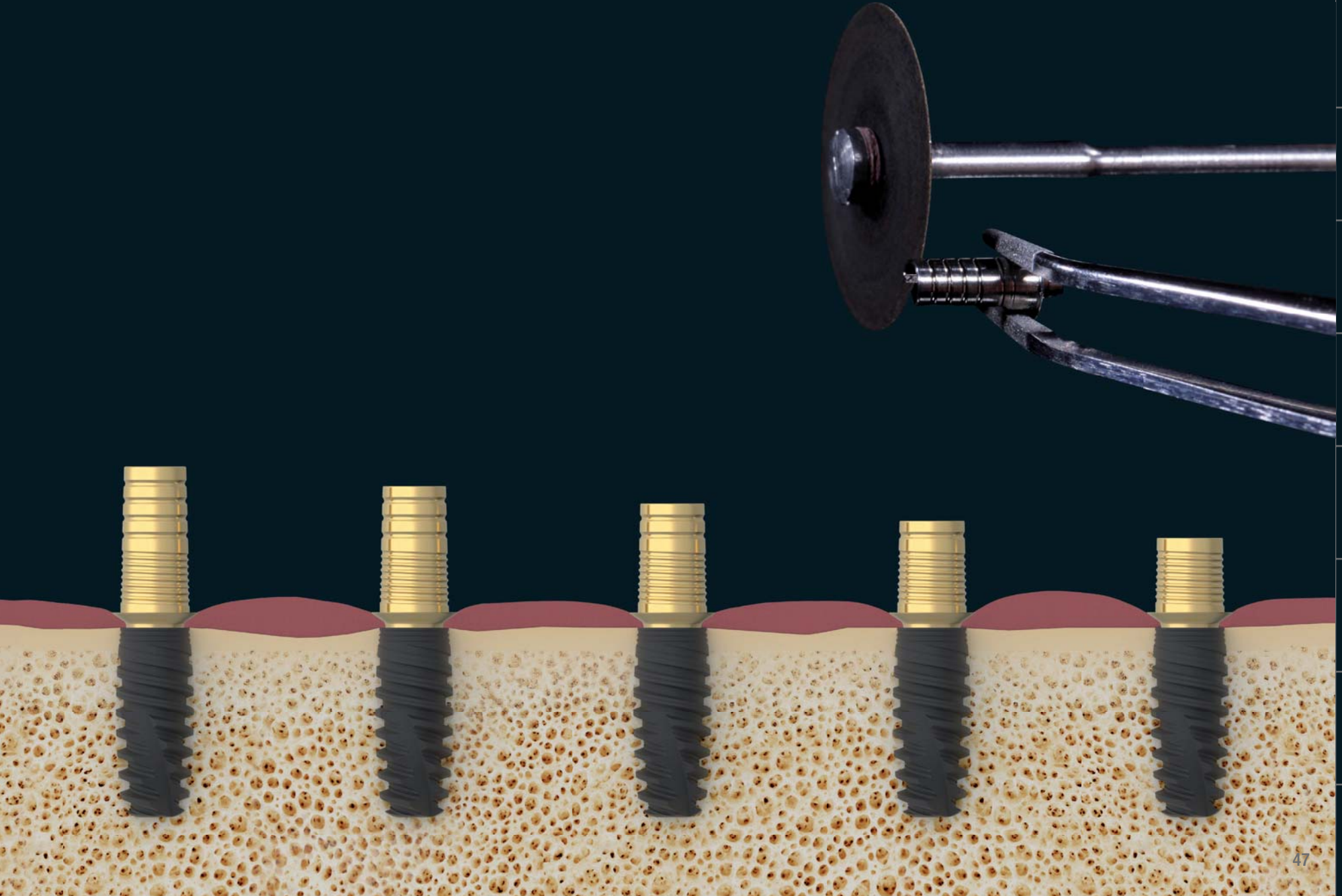

ABUTMENT SCREW METAL

This abutment screw is suitable to fix titanium bases, Scanmarkers and Raw-Abutments®, but not for zirconia structures.



For titanium bases, Scanmarkers and metal structures with direct connection, not for zirconia abutments



With conical or flat screw head



Available gold-plated for increased biocompatibility; gold-plating prevents cold welding as well as the unintended loosening of the screw



Abutment Screw Black: screw for fixing the final restoration in the mouth with increased resistance and special coating



Abutment Screw Laboratory: temporary screw for fixing the structure on the model

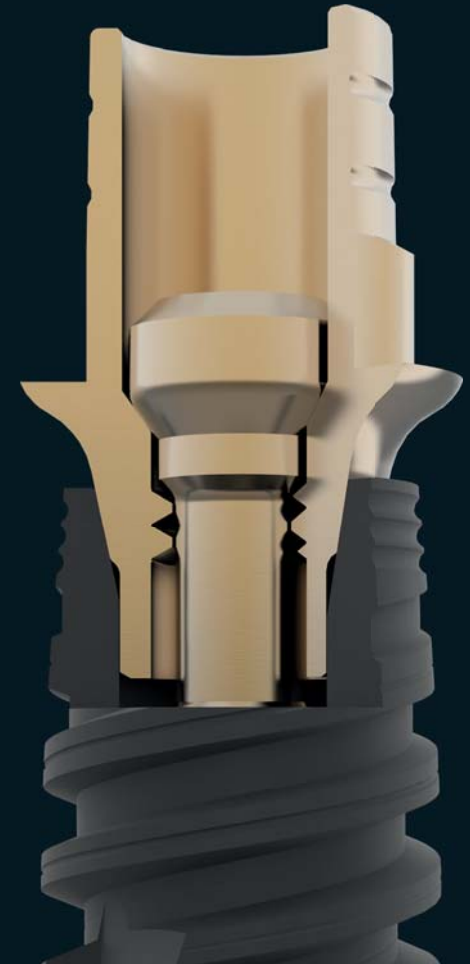

ABUTMENT SCREW ZIRCONIA

This abutment screw with flat screw head is ideal for fixing directly screwed zirconia or resin structures. However, we generally recommend the use of titanium bases for all implant-supported restorations.



For individual abutments made of zirconia and resin



With flat screw head



Available gold-plated for increased biocompatibility; gold-plating prevents cold welding as well as the unintended loosening of the screw



Abutment Screw Black: screw for fixing the final restoration in the mouth with increased resistance and special coating



Abutment Screw Laboratory: temporary screw for fixing the structure on the model



APPLICATION

Titanium bases, Raw-Abutments® and Scanmarkers can be fixed to the implant using the Abutment Screw Metal. On monolithic zirconia abutments, screws with flat seat must be used, in order to avoid tensions in the zirconia which, in the worst case, can lead to cracks in the abutment.



or



ABUTMENT SCREW METAL

The screw seat can be conical or flat, depending on the implant system

only



ABUTMENT SCREW ZIRCONIA

Only with flat screw seat for monolithic zirconia and resin

RIGHT

Abutment Screw
Zirconia



Zirconia
abutment



Implant



RIGHT

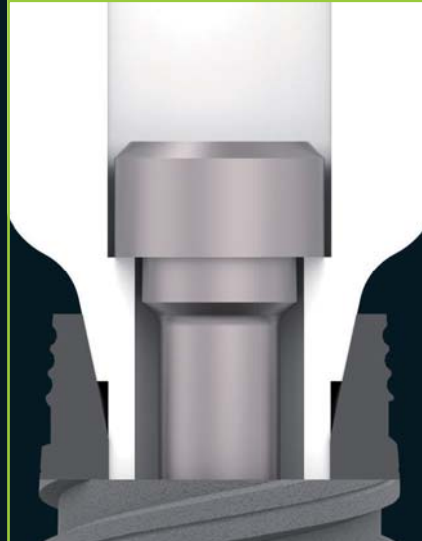

WRONG

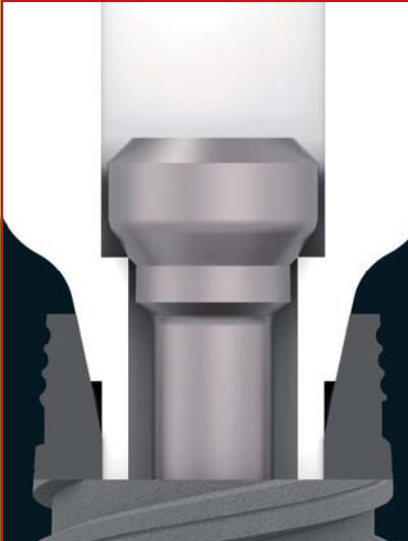

WRONG

Abutment Screw
Metal



Zirconia
abutment



Implant



ZIRKONZAHN MULTI UNIT ABUTMENT NON HEX

Multi Unit Abutments NON HEX without anti-rotation connection as well as anti-rotation device on the platform, are especially suited for multi-unit restorations and are designed in one piece to prevent bacterial entrance. The application of the Multi Unit Abutments NON HEX is extremely easy, because all types of implants have been adapted on a standard connection. In order to offer the best possible solution for every case, they are also available in five different gingival heights.



For multi-unit restorations



Conical Titanium Base as component of the Multi Unit Abutment



Without anti-rotation connection as well as anti-rotation device on the platform



Also available gold-plated for increased biocompatibility and reduced grey values



Available in different gingival heights



ZIRKONZAHN MULTI UNIT ABUTMENT 17°

Zirkonzahn Multi Unit Abutments 17° are available with an angle of 17° to compensate for any inclinations of the implants and with two different anti-rotation connection types which allow intermediate positions. They can be used for single crowns and multi-unit restorations.



For single crowns and multi-unit restorations



Conical Titanium Base, Parallel Titanium Base and Parallel Titanium Base One Position as components of the Multi Unit Abutment 17°. One Position titanium bases are used to screw single crowns on Multi Unit Abutments 17° with anti-rotation device



With anti-rotation connection as well as anti-rotation device on the platform



Also available gold-plated for increased biocompatibility and reduced grey values



Available in different gingival heights

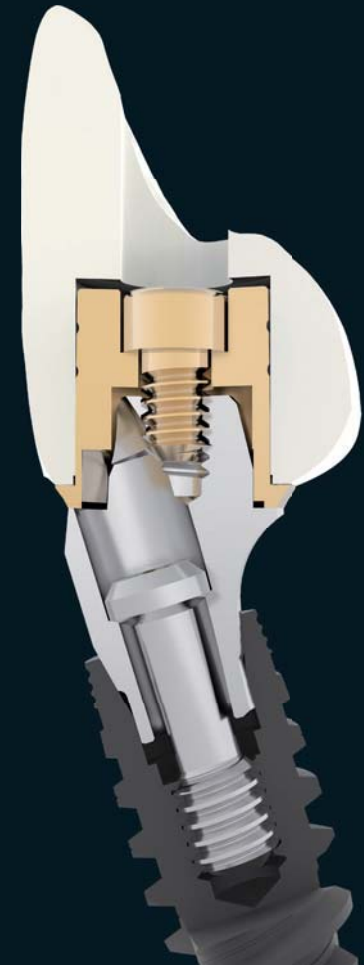

ZIRKONZAHN MULTI UNIT ABUTMENTS

The Zirkonzahn Multi Unit Abutments and Multi Unit Abutments 17° are especially suited for multi-unit restorations. They are available for all existing implant systems and their connections to the secondary structure are standardised: for this reason, the secondary structure can be screwed directly or with additional titanium bases to different implants without any problems. A further advantage of the standardised connection is that using these abutments, also other components (e.g. titanium bases, Scanmarkers, etc.) are reduced to one connection and divergences can be compensated.

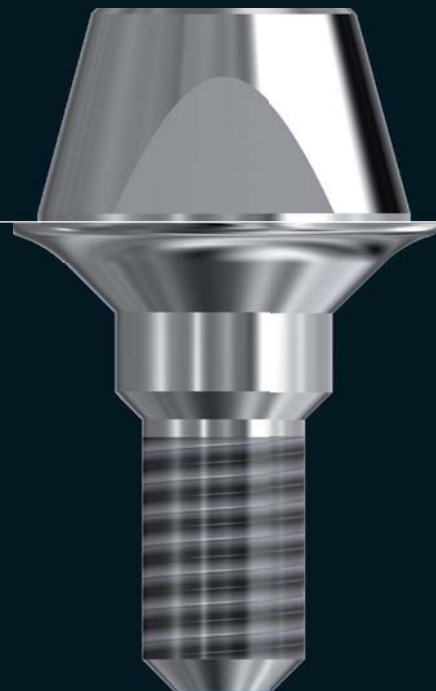

ZIRKONZAHN MULTI UNIT
ABUTMENT NON HEX



ZIRKONZAHN MULTI UNIT
ABUTMENT 17°

*Restoration fixed on two
Multi Unit Abutments and two
Multi Unit Abutments 17°,
which allow to compensate the
implants' diverging axes.*

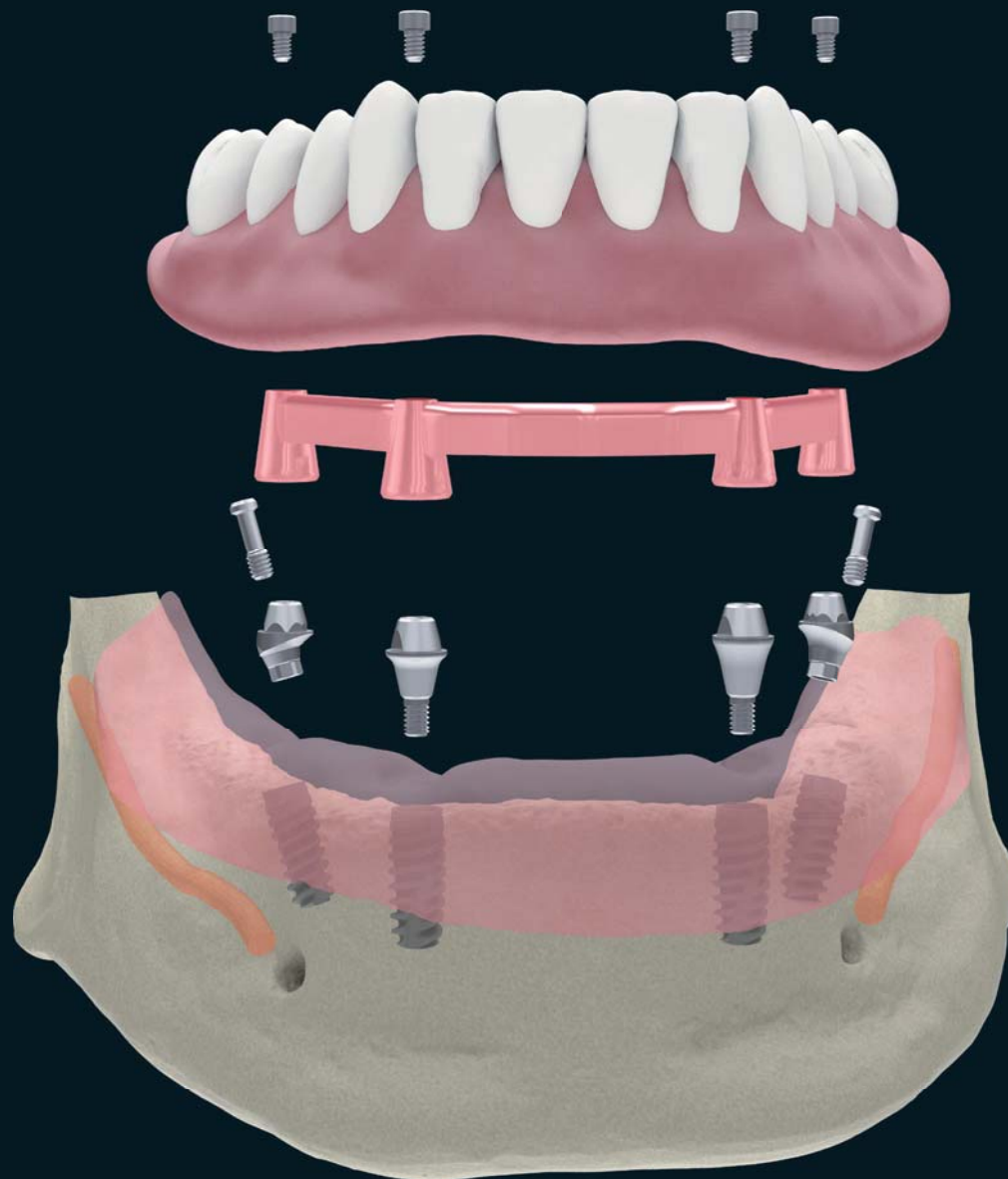

FOR MULTI-UNIT RESTORATIONS

NON HEX



Conical Titanium Base NON HEX +
Abutment Screw Metal



Multi Unit Abutment NON HEX + Abutment
Screw Metal



Multi Unit Abutment 17° +
Implant Screw + Insertion Tool



Implant

FOR SINGLE CROWNS

HEX



Narrow Titanium Base HEX Six Position +
Abutment Screw Metal



Narrow Titanium Base HEX One Position +
Abutment Screw Metal



Multi Unit Abutment 17° +
Implant Screw + Insertion Tool



Implant

COMMON COMPONENTS



Impression coping



Healing Cap Pink; anodised

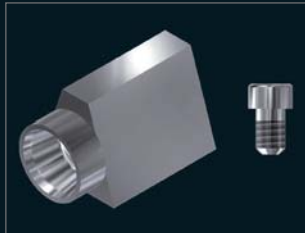

Scanmarker +
Abutment Screw Metal



White Scanmarker +
Abutment Screw Metal



White Metal Scanmarker
(with integrated screw)



Laboratory Analogue



ScanAnalog

TOOLS



Screwdriver 0,05" short, medium
and long



Torque Ratchet Wrench



Screwdriver L10, L15, L20 and L35



Screwdriver Zirkonzahn MUA



Adapter Ratchet Wrench

CONNECTION POSSIBILITIES MULTI UNIT ABUTMENT

Depending on the implant position, with the two different connection types (1 and 2) the number of connection possibilities has doubled.

Side view

Top view

MUA can be placed in different positions by each connection type (e.g. on every 60° of a HEX connection).

Having the possibility to choose a further connection type, the MUA can be placed in intermediate positions (e.g. on every 30° of a HEX connection).

HEX connection
Type 1

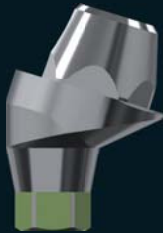

HEX connection
Type 2

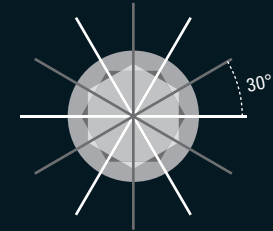
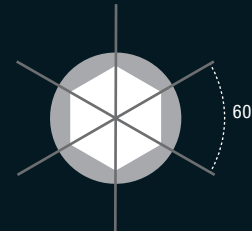

Triangular connection
Type 1

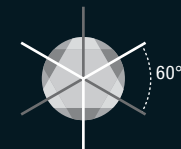

Triangular connection
Type 2



Square connection
Type 1

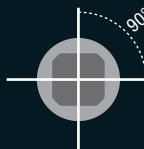

Square connection
Type 2



Octagonal connection
Type 1

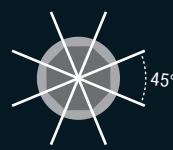

Octagonal connection
Type 2



ZIRKONZAHN LOC-CONNECTOR

Zirkonzahn LOC-Connector is a snap attachment for implants and bars that is used to fix removable dental prostheses on the implants. Zirkonzahn LOC-Connectors combine the advantages of removable and fixed prostheses and their snap-on mechanism allows both patients and dentists to insert and remove the restoration easily. They can be used for bridges only and on Zirkonzahn Multi Unit Abutments, Multi Unit Abutments 17° and metal bars.



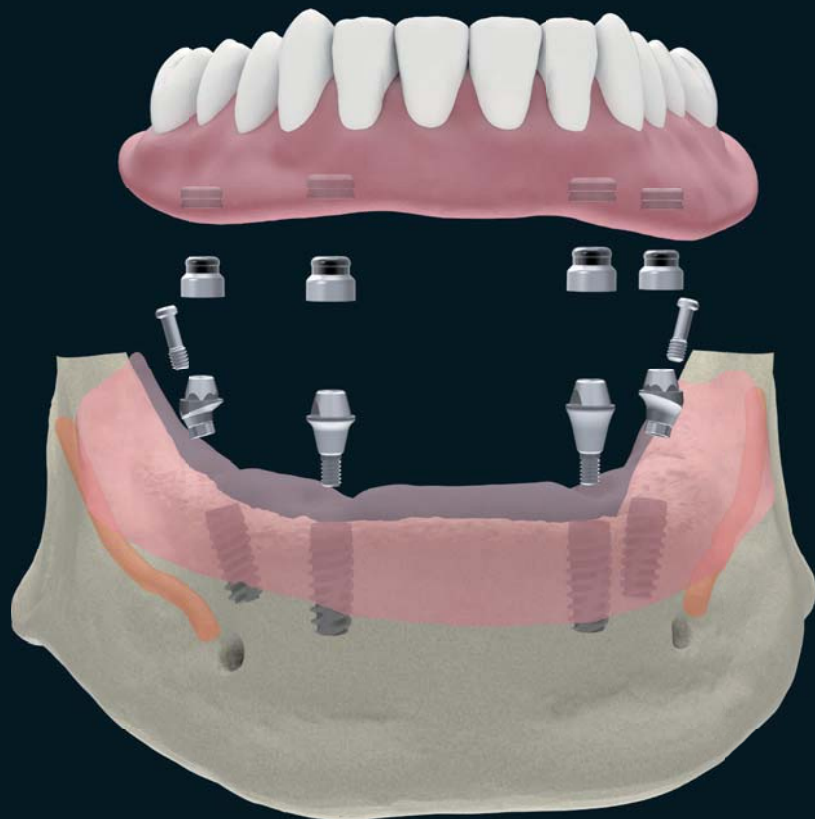

Zirkonzahn LOC-Connectors on Zirkonzahn Multi Unit Abutments

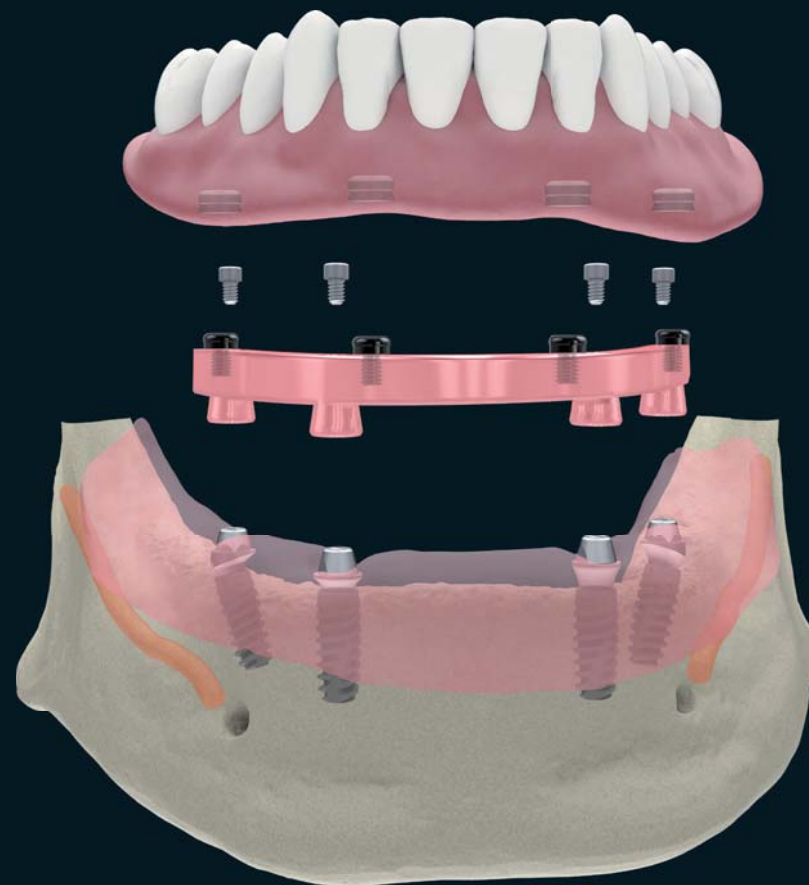

Zirkonzahn LOC-Connectors on a titanium bar

RAW-ABUTMENT® HEX

Our Raw-Abutments® are made of a high-quality medical titanium alloy (Ti-6Al-4V ELI according to ASTM F136 and ISO 5832-3) and enable the manufacture of customised one-piece abutments thanks to their industrially prefabricated implant connections, which guarantee the highest precision and fitting accuracy. In addition, the individual design of the abutment geometry compensates for implant divergences, preventing the vestibular protrusion of the screw channel and ensuring highly aesthetic restorations. Special milling strategies and milling burs are then used to provide the Raw-Abutments® with a particularly smooth surface structure. Depending on the implant system, different Raw-Abutment® blanks are required.



*For single crowns and multi-unit restorations
(especially for cemented, non-removable restorations)*



With anti-rotation connection



*Available with a diameter of 10 mm and 14 mm;
Ø 14 mm optimal for molar region*



*Can be anodised in different colours with the
Titanium spectral-colouring Anodizer*



Using special Raw-Abutment® holders in Ø 95 mm or Ø 125 mm, it is possible to mill up to three or six Raw-Abutments® in just one process.



ZIRKONZAHN TITANIUM POST

The Zirkonzahn Titanium Posts are root posts made of a medical titanium alloy. They are used to reconstruct teeth with extensive coronal defects. Using special attachments, the position and inclination of the posts can be determined for the next working steps in the design software.

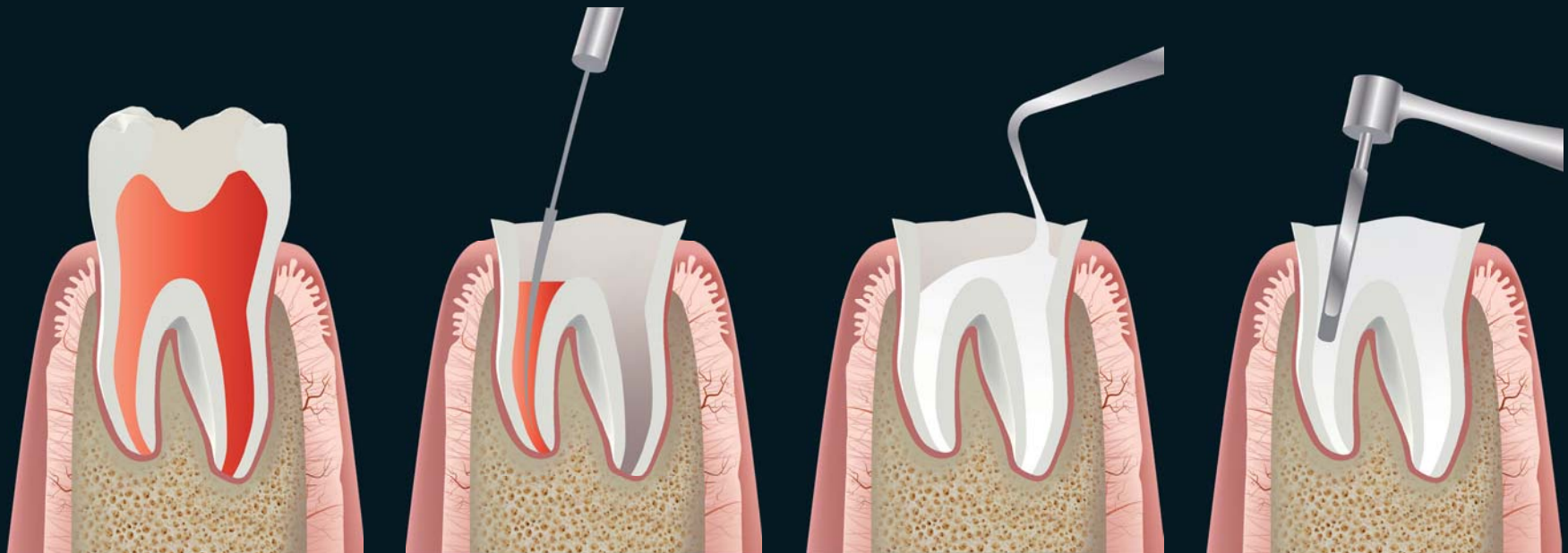

Inflamed tooth

The nerves are removed and the canals are cleaned

The root is filled with a special filling material

Drilling the root canal

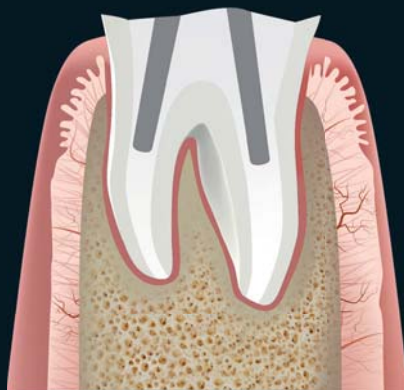

Preparing the post canals

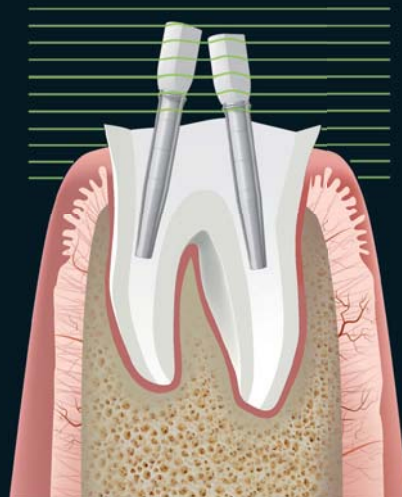

Insertion of the Titanium Posts with special attachments; digitisation

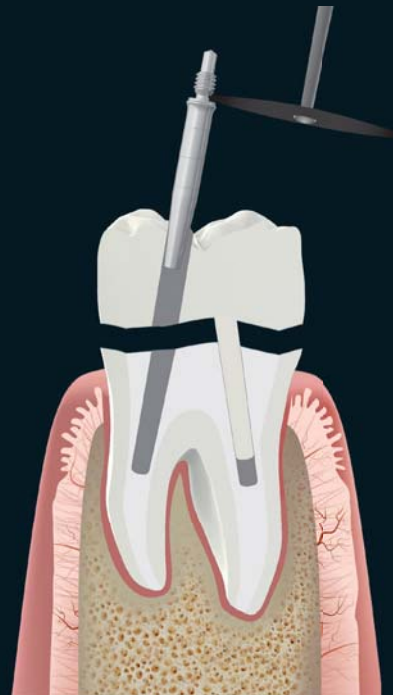

Shortening the titanium post; insertion of the crown, designed with a fixed post



Sealing the post canal in the crown

TOOLS

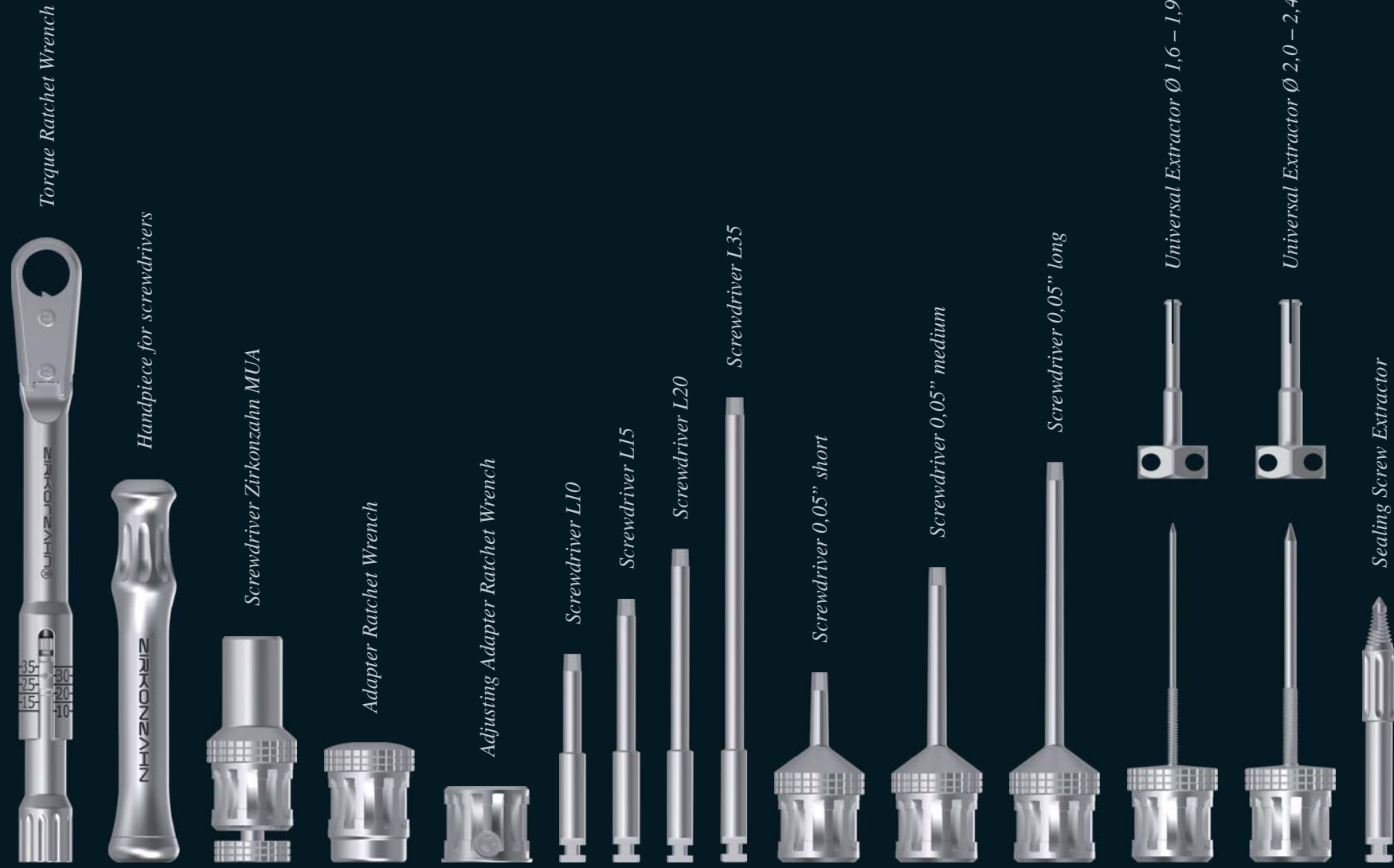

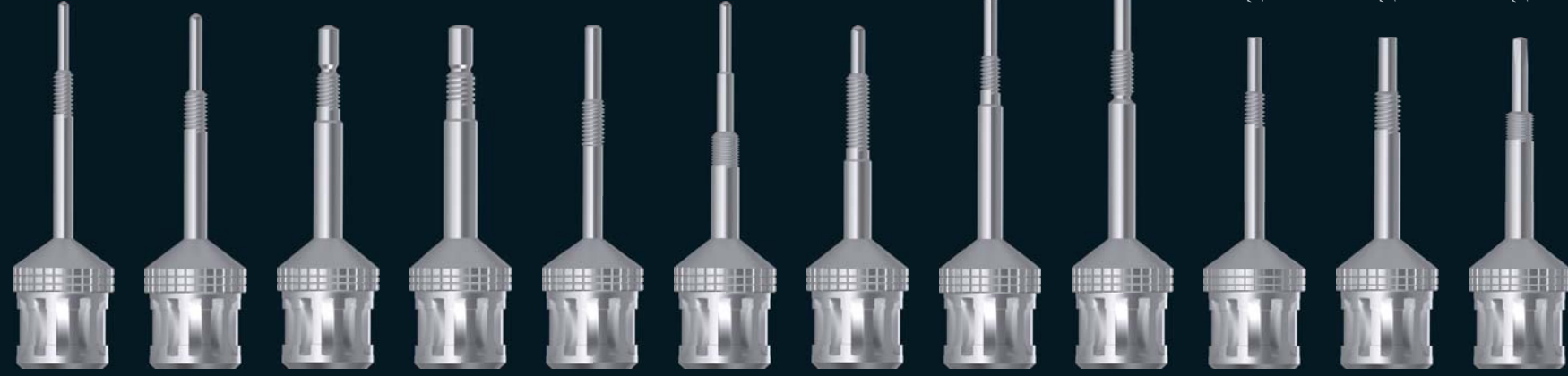

Titanium Base Extractor Biotech 3.0

Titanium Base Extractor Biotech 3.6-5.4

Titanium Base Extractor Camlog Conelog 3.3-4.3

Titanium Base Extractor Camlog Conelog 5.0

Titanium Base Extractor Friadent Dentsply Ankylos 3.5-7.0

Titanium Base Extractor K3 Mini

Titanium Base Extractor K3 Standard

Titanium Base Extractor MIS Narrow

Titanium Base Extractor MIS Standard/Wide

Titanium Base Extractor Nobel Biocare Nobel Active NP

Titanium Base Extractor Nobel Biocare Nobel Active RP/WP

Titanium Base Extractor Tekka In-Kone 3.5-5.5

TITANIUM BASE EXTRACTOR

Abutments are fitted to laboratory analogues or implants directly on the model or in the patient's mouth and then screwed. If the abutment is fixed on an implant with a flat-angled connection, a frictional connection is created. In the conventional manual way, the two components cannot be separated from each other without causing some damage. By using the Titanium Base Extractor this is possible without overstressing the osseointegrated parts.

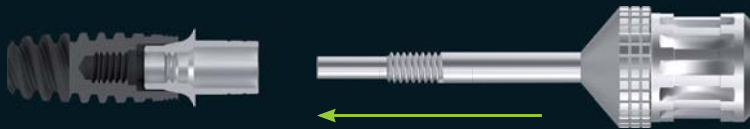

The Titanium Base Extractor is screwed into the internal thread of the abutment...

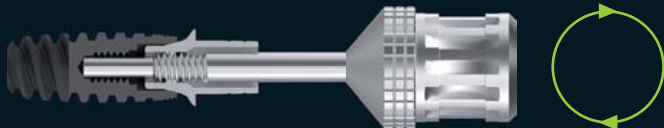

...until the bottom is reached.

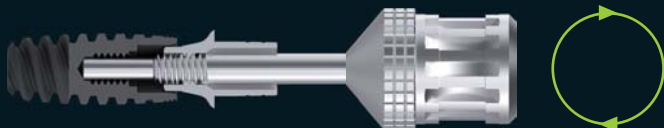

A further screwing...



...ensures a damage-free removal of the abutment from the implant or laboratory analogue.

TITANIUM BASE EXTRACTOR A15

The Titanium Base Extractor A15 is used to remove abutments from implants or laboratory analogues without overstressing the osseointegrated parts. Thanks to its unified right angled shank, it can be used in combination with the Adapter Ratchet Wrench or with the handpiece for screwdrivers. In situations with limited space, the Titanium Base Extractor A15 can also be individually shortened with the Adjusting Adapter Ratchet Wrench.

Insert the Titanium Base Extractor A15 into the Adapter Ratchet Wrench and remove the abutment from the implant.



Insert the Titanium Base Extractor A15 into the handpiece for screwdrivers and remove the abutment from the laboratory analogue.



The system library for our Titanium Base Extractors A15 is constantly expanded.

UNIVERSAL EXTRACTOR

The Universal Extractor is used to remove directly screwed secondary structures (e.g. made of metal or resin) as well as titanium bases without internal threads from implants with flat-angle connection geometries.



SEALING SCREW EXTRACTOR

With the Sealing Screw Extractor, sealing screws can be loosened from zirconia structures without damaging the threaded screw channel.

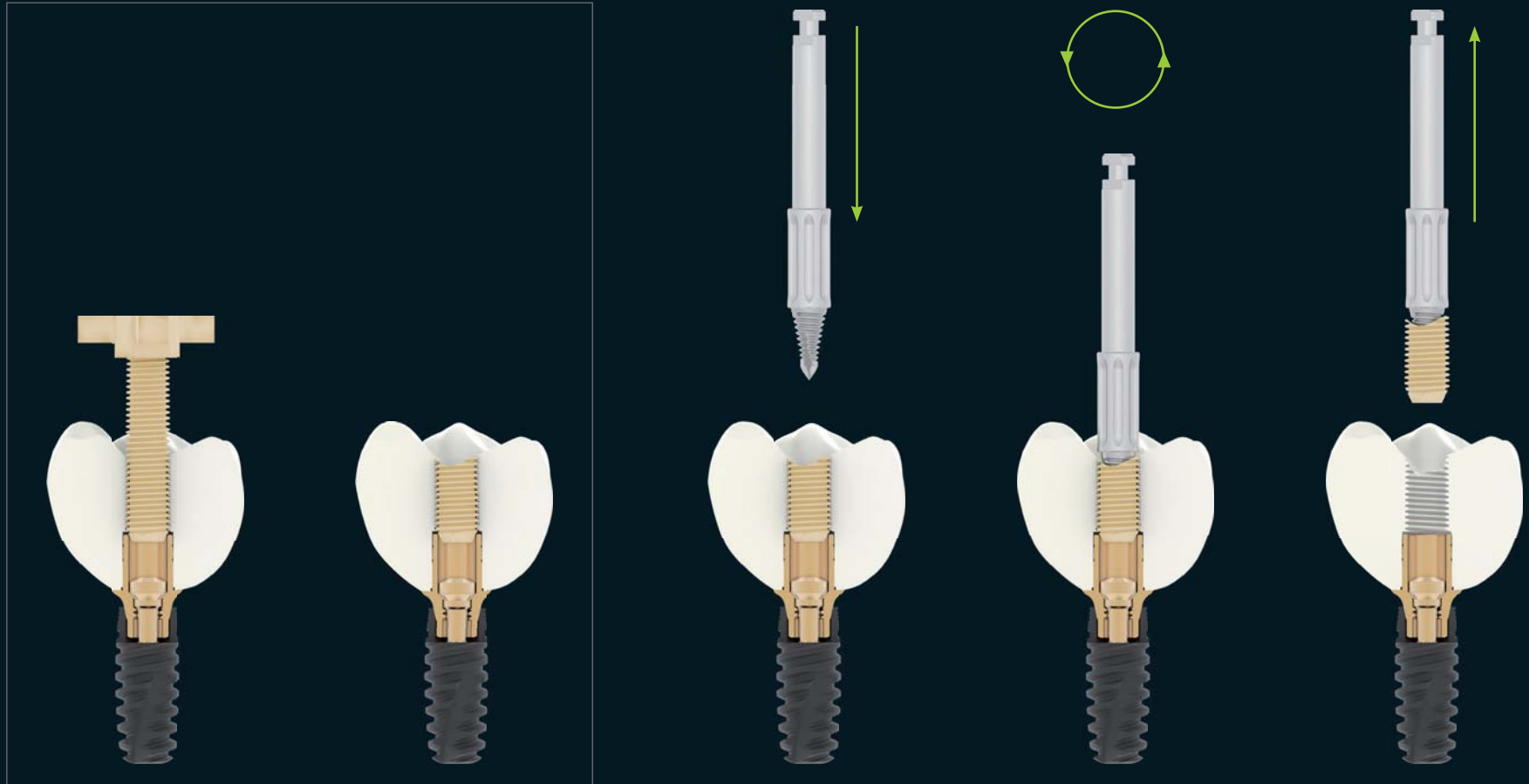

SCREW EXTRACTOR RESCUE KIT

With the Screw Extractor Rescue Kit it is possible to remove from the implant a broken abutment screw. Using a left-rotating drill and a drill guide, which must be placed accurately on the implant, the screw can be removed without causing damage to the implant.

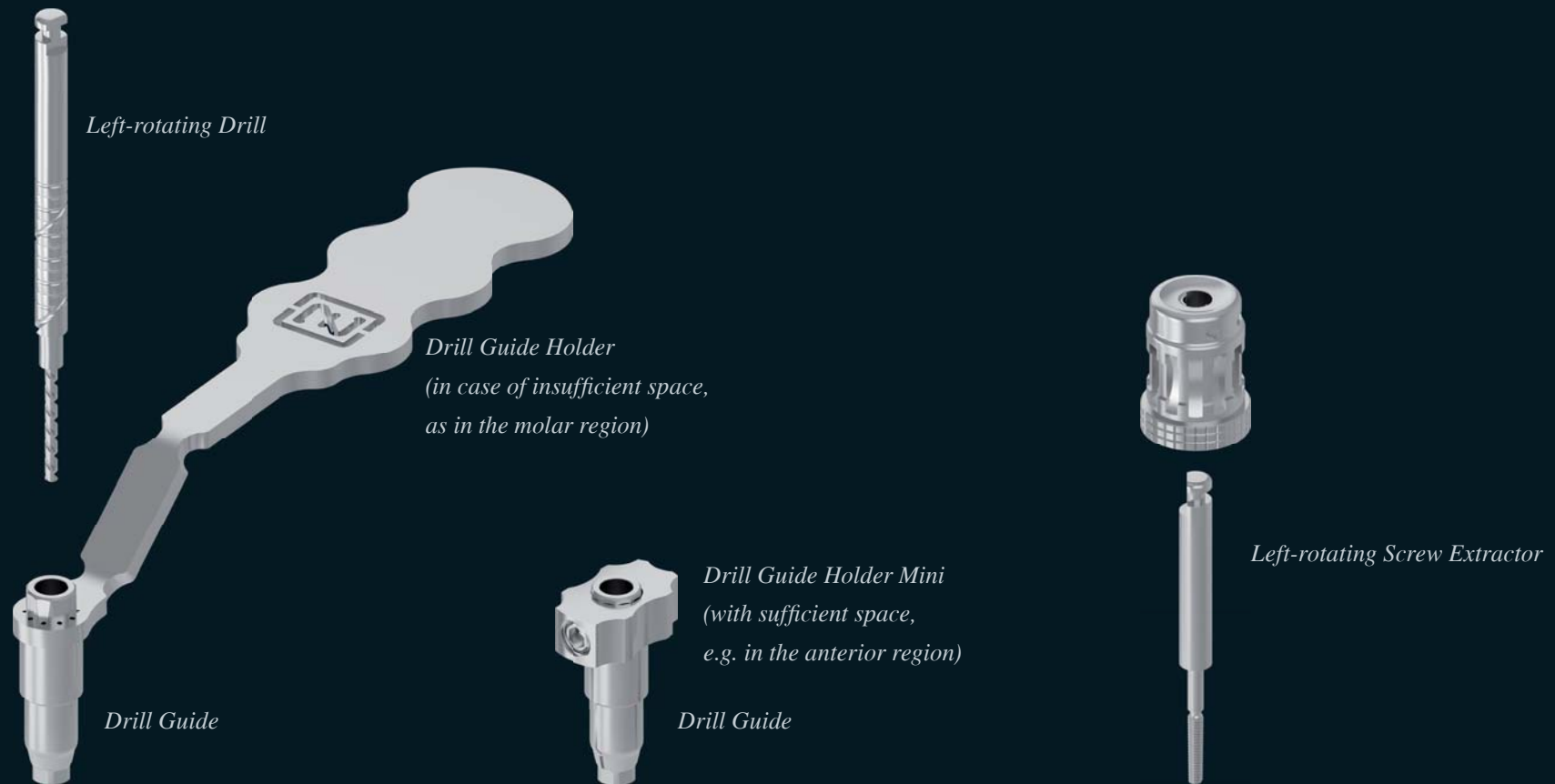

Watch the video for a detailed description



The drill guide is equipped with a “drill stop” which prevents the drill from damaging the implant. After the drilling process, the drill and its guide can be removed from the implant. If the screw is already loosened, it can be removed easily.

If the screw has not loosened from the implant yet, the Screw Extractor and the Adapter Ratchet Wrench are required. After screwing the Screw Extractor, it is possible to remove the screw.



UNIVERSAL SCREWDRIVER SET

Tool set to fix and loosen abutment screws. The set consists of the new Torque Ratchet Wrench, Adapter Ratchet Wrench and several screwdrivers, which are available for different implant systems and in different lengths.



Torque Ratchet Wrench



Adapter Ratchet Wrench



Depending on the system, the screwdriver is available in different lengths (short, medium, long, extra-long)



The screwdriver can be individually equipped: depending on the system, it is available in different lengths (short, medium, long, extra-long)



Torque Ratchet Wrench

Handpiece for screwdrivers



Screwdriver

Zirkonzahn MUA

Adapter Ratchet Wrench



SCREWDRIVER ZIRKONZAHN FOR MUA

The screwdrivers are used in combination with the Torque Ratchet Wrench to fix and loosen the Multi Unit Abutments NON HEX.

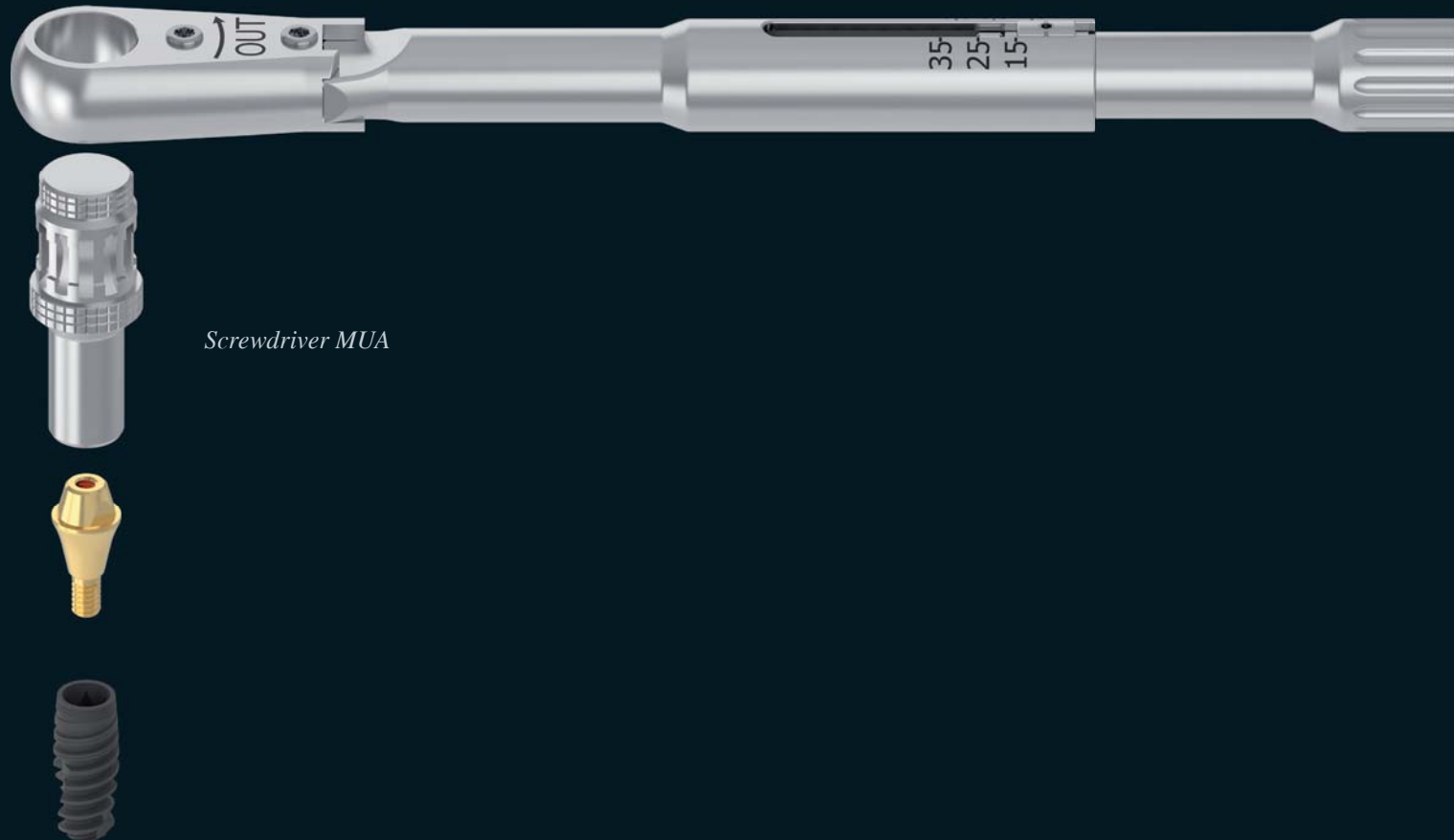

Screwdriver MUA

ADJUSTING ADAPTER RATCHET WRENCH

The Adjusting Adapter Ratchet Wrench is used for the alternative insertion of Zirkozahn screwdrivers with right angled shank into the Torque Ratchet Wrench.

In situations with limited space, e.g. in the molar region, its special design allows the use of screwdrivers with reduced length. In order to determine the ideal length, it is necessary to insert the appropriate screwdriver into the Adjusting Adapter Ratchet Wrench and mark the desired length. The screwdriver can be then shortened, reinserted into the Adjusting Adapter Ratchet Wrench and fixed in place using three clamping screws.

The Adjusting Adapter Ratchet Wrench is suitable for use both in laboratory and in patient's mouth.

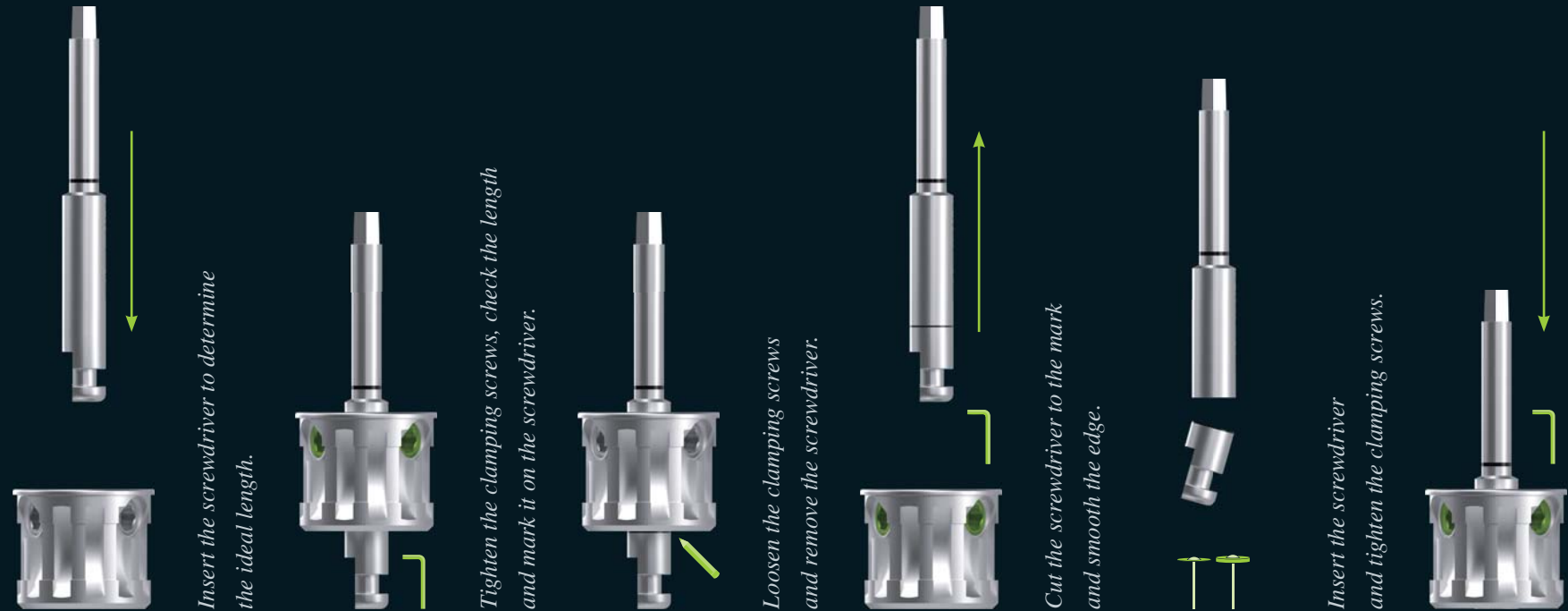

DOUBLE SCREW METAL TECHNIQUE

The production of full-arch prosthetics on divergent implants is one of the most challenging jobs.

With the new Double Screw Metal function of the Zirkonzahn.Modellier software (CAD/CAM Attachment software module), additional screws can be integrated to screw the secondary structure to the titanium bar. Thanks to this new function, it is possible to visualise the screw virtual positions and generate virtual screw threads within the bar design. The 3D rendering also provides the optimal position of the screw channel in the primary structure, as well as the ideal fit of the screw head in the superstructure. The screw channels generated in the software are integrated in the bar during milling. The titanium bar is then screwed to the implants and the secondary structure to the bar.



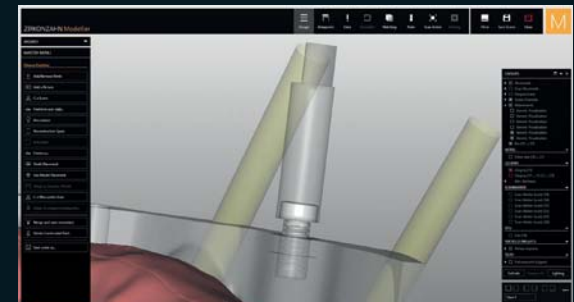
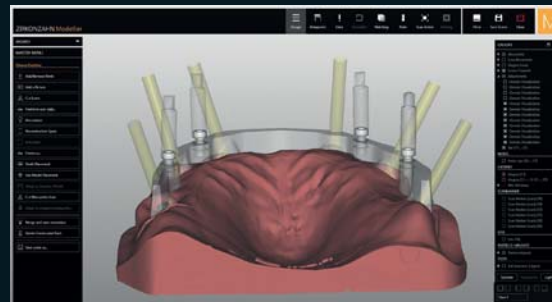
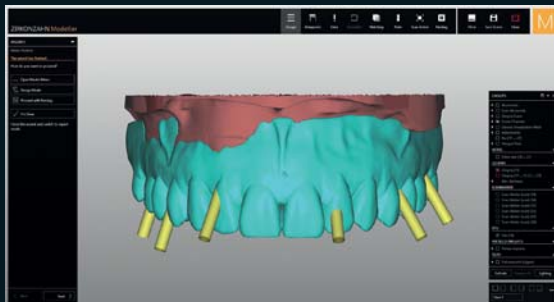



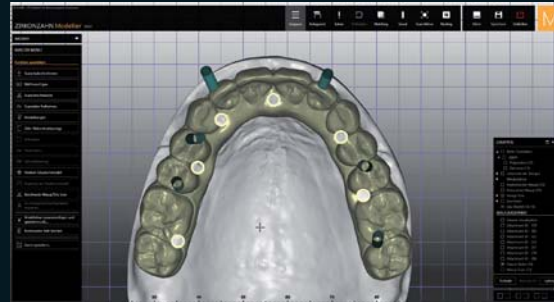
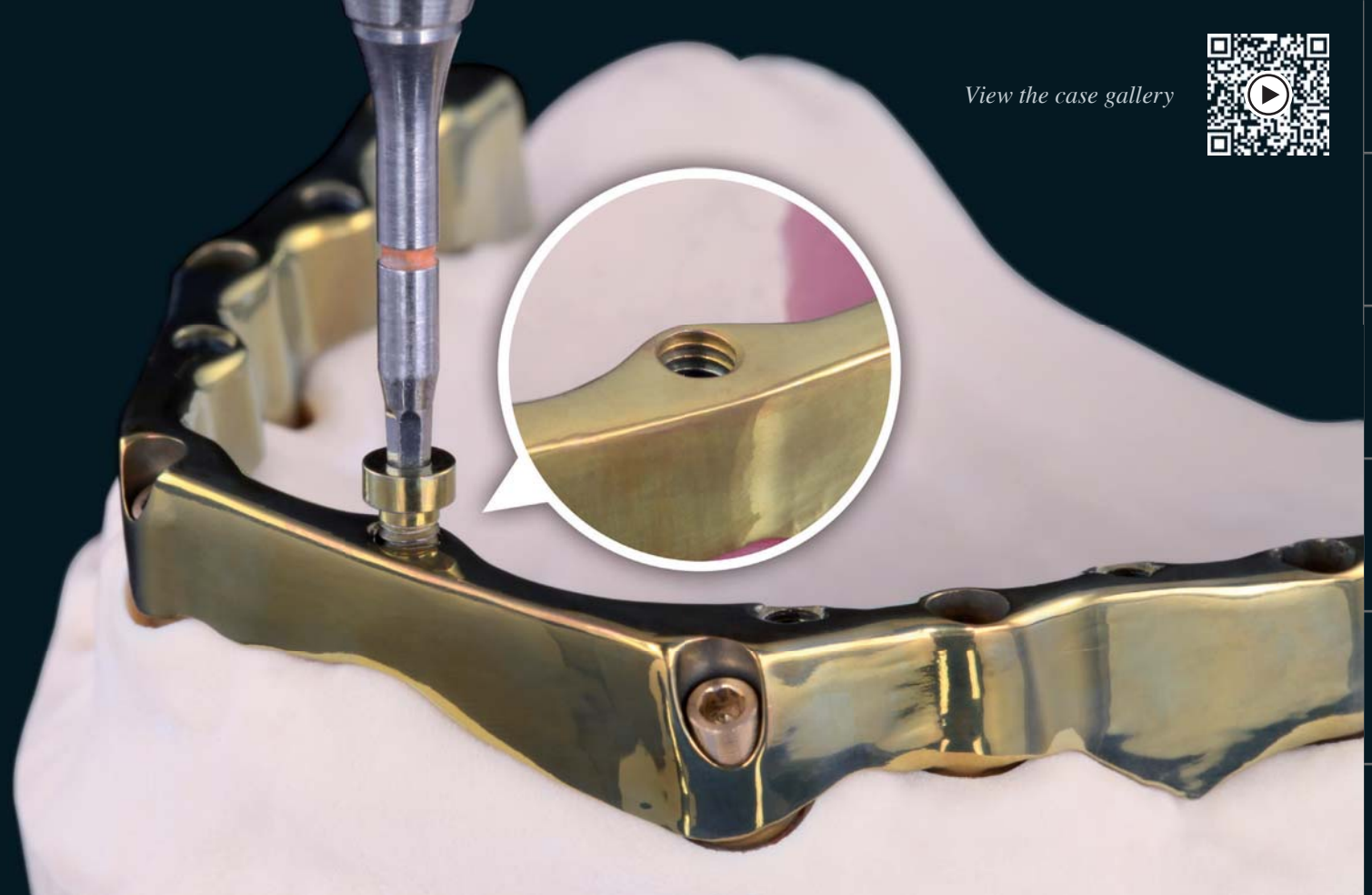



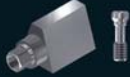





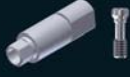

With the Double Screw Metal technique it is now possible to avoid unaesthetic vestibular channels, in order to produce highly stable, bar-supported rehabilitations even in complex cases without compromising the full arch aesthetics.



















View the case gallery











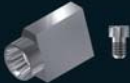







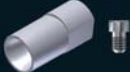





















AVAILABLE SETS

| ANALOGUES | SCANMARKERS | TRANSFER | RAW-ABUTMENTS® | TITANIUM BASES | | | |
|--|--|--|---|--|--|---|---|
| <p>Laboratory Analogue</p>  | <p>Scanmarker + Abutment Screw Metal</p>  | <p>Impression coping</p>  | <p>Raw-Abutment® HEX + Abutment Screw Metal</p>  | <p>Narrow Titanium Base HEX + Abutment Screw Metal</p>  | <p>Narrow Titanium Base HEX Gold + Abutment Screw Metal Gold</p>  | <p>Parallel Titanium Base HEX + Abutment Screw Metal</p>  | <p>Parallel Titanium Base HEX Gold + Abutment Screw Metal Gold</p>  |
| | <p>White Scanmarker + Abutment Screw Metal</p>  | | <p>Raw-Abutment® D14 HEX + Abutment Screw Metal</p>  | <p>Narrow Titanium Base NON HEX + Abutment Screw Metal</p>  | <p>Narrow Titanium Base NON HEX Gold + Abutment Screw Metal Gold</p>  | <p>Conical Titanium Base NON HEX + Abutment Screw Metal</p>  | <p>Conical Titanium Base NON HEX Gold + Abutment Screw Metal Gold</p>  |
| | <p>White Metal Scanmarker</p>  | | | | | <p>Parallel Titanium Base HEX K85 + Abutment Screw Metal</p>  | <p>Parallel Titanium Base HEX K85 Gold + Abutment Screw Metal Gold</p>  |
| <p>ScanAnalog</p>  | | | | | | <p>Conical Titanium Base NON HEX K85 + Abutment Screw Metal</p>  | <p>Conical Titanium Base NON HEX K85 Gold + Abutment Screw Metal Gold</p>  |

| TITANIUM BASES | | SCREWS | | | | TOOLS | |
|--|--|--|---|---|--|---|--|
| <p>Titanium Base HEX K80 Angled Screw Channel (ASC) + Abutment Screw</p>  | <p>Titanium Base HEX K80 Angled Screw Channel (ASC) Gold + Abutment Screw Metal Gold</p>  | <p>Abutment Screw Metal</p>  | <p>Abutment Screw Metal Gold</p>  | <p>Abutment screw Metal Laboratory</p>  | <p>Abutment Screw Metal Black</p>  | <p>Screwdriver</p>  | <p>Torque Ratchet Wrench</p>  |
| <p>Titanium Base NON HEX K80 Angled Screw Channel (ASC) + Abutment Screw</p>  | <p>Titanium Base NON HEX K80 Angled Screw Channel (ASC) Gold + Abutment Screw Metal Gold</p>  | <p>Abutment Screw Zirconia</p>  | <p>Abutment Screw Zirconia Gold</p>  | <p>Abutment Screw Zirconia Laboratory</p>  | <p>Abutment screw Zirconia Black</p>  | <p>Sealing Screw Extractor</p>  | <p>Universal Extractor or Titanium Base Extractor or Titanium Base Extractor A15</p>  |
| | | | | | | <p>Screw Extractor Rescue Kit</p>  | |

AVAILABLE SETS ZIRKONZAHN MUA

| ANALOGUES | SCANMARKERS | TRANSFER | HEALING CAPS | LOC-CONNECTOR | MULTI UNIT ABUTMENTS | TITANIUM BASES | | |
|--|--|--|--|---|---|---|---|---|
| <p>Laboratory Analogue</p>  | <p>Scanmarker + Abutment Screw Metal</p>  | <p>Impression coping</p>  | <p>Healing Cap Grey; can be anodised</p>  | <p>LOC-Connector</p>  | <p>Multi Unit Abutment NON HEX + Abutment Screw Metal</p>  | <p>Multi Unit Abutment NON HEX Gold + Abutment Screw Metal Gold</p>  | <p>Conical Titanium Base NON HEX + Abutment Screw Metal</p>  | <p>Conical Titanium Base NON HEX Gold + Abutment Screw Metal Gold</p>  |
| | <p>White Scanmarker + Abutment Screw Metal</p>  | | <p>Healing Cap Gold; anodised</p>  | | <p>Multi Unit Abutment 17° + Implant Screw + Insertion Tool</p>  | <p>Multi Unit Abutment 17° Gold + Implant Screw Gold + Insertion Tool</p>  | <p>Narrow Titanium Base HEX + Abutment Screw Metal</p>  | <p>Narrow Titanium Base HEX Gold + Abutment Screw Metal Gold</p>  |
| | <p>White Metal Scanmarker + Abutment Screw Metal</p>  | | <p>Healing Cap Pink; anodised</p>  | | | | <p>Narrow Titanium Base HEX One Position + Abutment Screw Metal</p>  | <p>Narrow Titanium Base HEX One Position Gold + Abutment Screw Metal Gold</p>  |
| <p>ScanAnalog</p>  | | | | | | | | |

| TITANIUM BASES | | SCREWS | | | | TOOLS | |
|--|---|--|---|---|--|---|---|
| <p>Conical Titanium Base NON HEX K85+ Abutment Screw Metal</p>  | <p>Conical Titanium Base NON HEX K85 Gold + Abutment Screw Metal Gold</p>  | <p>Abutment Screw Metal</p>  | <p>Abutment Screw Metal Gold</p>  | <p>Abutment Screw Metal Laboratory</p>  | <p>Abutment Screw Metal Black</p>  | <p>Screwdriver Zirkonzahn MUA</p>  | <p>Screwdriver</p>  |
| | | <p>Abutment Screw Zirconia</p>  | <p>Abutment Screw Zirconia Gold</p>  | <p>Abutment Screw Zirconia Laboratory</p>  | <p>Abutment Screw Zirconia Black</p>  | <p>Torque Ratchet Wrench</p>  | <p>Titanium Base Extractor or Titanium Base Extractor A15</p>  |
| | | <p>Implant Screw</p>  | <p>Implant Screw Gold</p>  | <p>Implant Screw Laboratory</p>  | <p>Implant Screw Black</p>  | <p>Sealing Screw Extractor</p>  | |

ZIRKONZAHN.SOFTWARE

When developing our Zirkonzahn.Software we adapted the strict standards of our proven products to its design and functionality. The well-structured and simply designed user interface characterises each software component, making it the cornerstone for a familiar and reliable application. When it comes to the creation of different features, our developing team, which obviously includes also dental technicians, follows a practical and result-oriented principle, which guarantees the greatest possible freedom of choice and processing. Furthermore, complex technological processes are designed in a comprehensive and transparent way. The user can decide whether he wants to use a step by step guide or if he wants to proceed individually. The different software programs with the corresponding modules are matched not only to each other, but also to the related hardware components. This ensures a 100% smooth workflow between dental technicians and dentists – from patient registration and articulation, to the design, production and insertion of the final restoration in the patient's mouth. Proven manual and digital working techniques can be combined in order to achieve the best possible patient-oriented restoration.



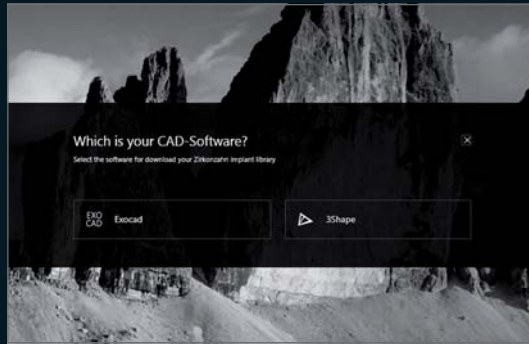

ZIRKONZAHN LIBRARY DOWNLOAD CENTER

- Zirkonzahn implant components for exocad® and 3Shape users
- Free program for importing and using all Zirkonzahn implant components in 3Shape or exocad® design software
- Fast download: implant libraries can be individually downloaded
- Always up to date: automatic update information for newly available systems or system components

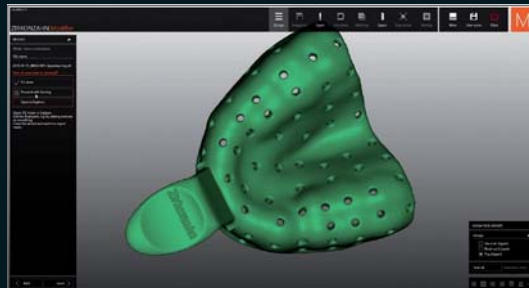

ZIRKONZAHN.TRAY SOFTWARE

- Step-by-step guided, open software for the production of individual impression trays
- Open STL data format – compatible with different production processes (e.g. 3D printing) and systems
- Possibility of individual design (edges, dimensions, retentions and holes)
- Adjustable tool sizes for a quick design



HEROES COLLECTION VIRTUAL TOOTH LIBRARY

- Virtual tooth library with ten natural and aesthetic tooth sets (for upper and lower jaw)
- For the design of all types of restoration; also for the creation of set-ups with rooted teeth. For subsequent use in the implant planning phase
- Fully anatomical or in four virtual cut-back designs (FIRE, WATER, AIR, EARTH) for veneering with ceramics

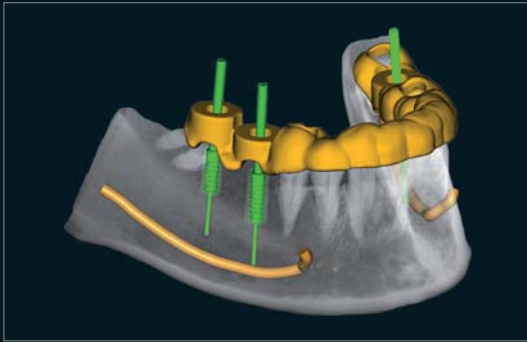

ZIRKONZAHN IMPLANT-PLANNER SOFTWARE

With the Zirkonzahn.Implant-Planner, the cooperation between the dentist and the dental laboratory can be brought to new levels, reconciling the planned aesthetic design of a prosthetic restoration with the planned implant situation.

- *3D implant planning software approved as medical device*
- *Intuitive software with step-by-step guide (Wizard)*
- *Compatible with all open DICOM data from CT-, CBCT-, DCM-devices*
- *Determination of the ideal implant position on the basis of bone density and patient individual data such as DICOM data, wax-up, intraoral and model scans as well as 3D facial scans. Manual adjustments are possible*
- *Conversion of DICOM data into STL data records for further processing with other CAD software (CAD/CAM STL- software module required)*
- *Wide implant libraries with different implant-prosthetic components compatible with all common implant systems; library with a wide range of drilling sleeves. The libraries are being constantly expanded.*
- *Export of the planned implant case for further processing by other software (ideally Zirkonzahn.Modellier) and for planning prosthetic restorations or models with laboratory analogues. Manufacturing with Zirkonzahn CAD/CAM milling units, CAD/CAM systems by other manufacturers or 3D printers*
- *Creation of surgical guides, which can be either tooth-borne, bone-borne or mucosa-borne and be fixed with pins*
- *Creation of customised impression trays (CAD/CAM Z-Tray software module required)*



Zirkonzahn.Implant Planner Viewer: download the demo version for free and test it right away!



ZIRKONZAHN.IMPLANT-PLANNER

Full version for the laboratory, with relevant tools for implant planning and for the production of surgical guides



ZIRKONZAHN.IMPLANT-PLANNER PRACTICE

Software version for the dental practice, with all relevant functions for implant planning only



ADDITIONAL ZIRKONZAHN.IMPLANT-PLANNER SOFTWARE MODULES (OPTIONAL)*

- CAD/CAM STL-Converter software module – Module for converting DICOM data into STL data for further processing with different CAD software
- CAD/CAM Z-Tray software module – Module for the production of individual impression trays

**at extra charge*

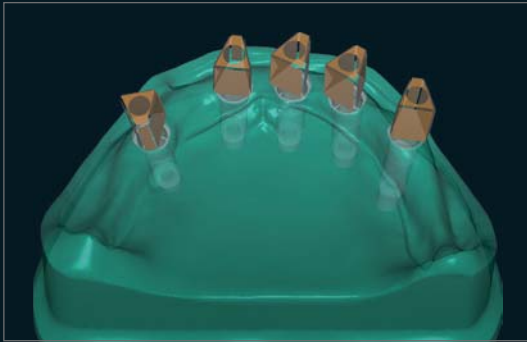

CAD/CAM MODEL MAKER SOFTWARE MODULE

- *Module for the production of different physical models (e.g. Geller models, models with implant analogues, dies, full-arch bridges) based on intraoral scan data as well as impression and model scans*
- *Customised parameters setting: e.g. distance between model and die, model thickness*
- *Automatic margin and undercut identification*
- *Exportable data for producing models with 3D printers*
- *Creation of positioning pins for transferring the digitally recorded occlusion into the laboratory articulator*
- *In combination with the Zirkonzahn.Implant-Planner: service package for dentists, consisting of implant model, impression tray, surgical guide and temporary restoration*

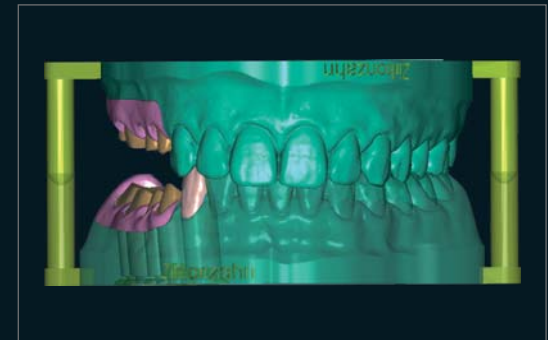
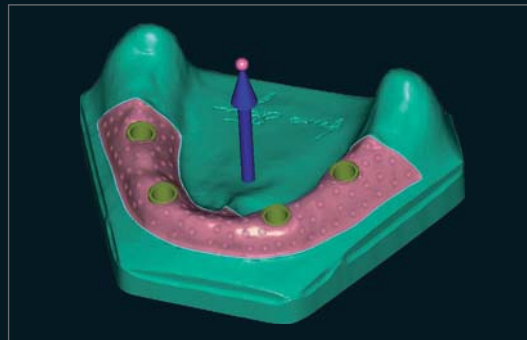
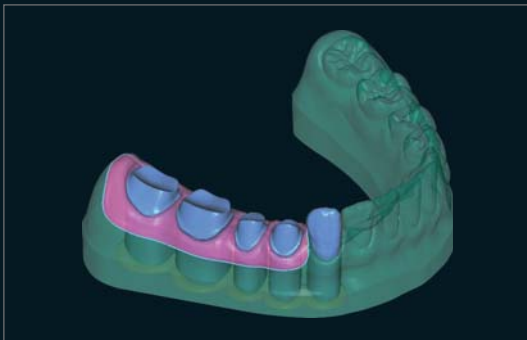

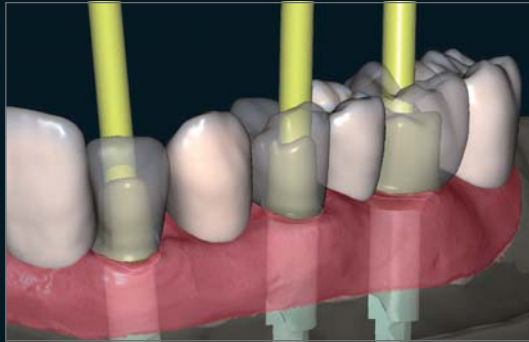

CAD/CAM ABUTMENTS SOFTWARE MODULE

- Module for the production of individual abutments and their emergence profile
- Abutments design by taking into account the secondary structure; adjustable crown bottom parameters
- Semi-transparent display of the outer tooth form for a much easier virtual abutments creation
- Compatible with all common implant systems, to be directly screwed in or by means of bonded titanium bases
- Adjustment of the implant position by virtual rotation (titanium bases K80 Angled Screw Channel – ASC)

Attention – it only works in combination with the CAD/CAM Occlusally Screwed Bridges software module

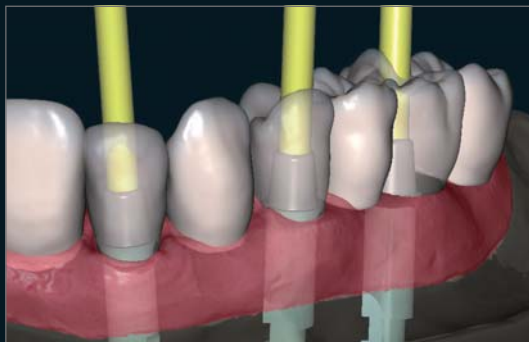

CAD/CAM OCCLUSALLY SCREWED BRIDGES SOFTWARE MODULE

- Module for the creation of occlusally screwed bridges and bars
- Free shaping of the emergence profile, taking into account the anatomic tooth shape and gingiva
- Using the scanbodies, the software calculates the alignment of the implants and uses it for the exact alignment of the screw channels
- Creation of threaded screw channels in the zirconia structure for sealing the restoration with sealing screws (made from the Screw Blank) in the patient's mouth. The restoration can be easily removed by unscrewing the screws with the extractor
- Adjustment of the implant position by virtual rotation (titanium bases K80 Angled Screw Channel – ASC)

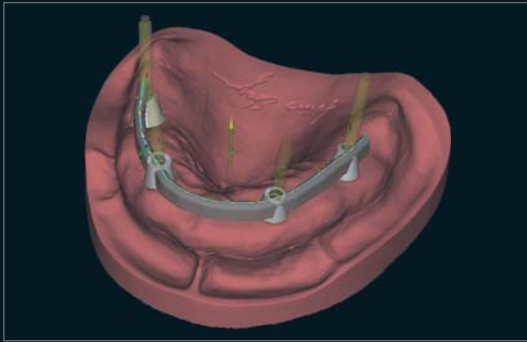

CAD/CAM BARS SOFTWARE MODULE

- *Module for the individual production of primary and hybrid bars (also implant-supported)*
- *Freely customisable emergence profile*
- *Semi-transparent display of the outer tooth form or separate situation scans for a much easier virtual bars creation*
- *The different available bar profiles can be easily modified*
- *Customised parameters setting: height, thickness, lingual and buccal angle, as well as many other individualisation options*
- *Possibility of fixing attachments, retentions, holes as well as anchorings*
- *Adjustment of the implant position by virtual rotation (titanium bases K80 Angled Screw Channel – ASC)*
- *Possibility of screwing the superstructure through special threaded screw channels milled in the bar. In combination with the CAD/CAM Attachment software module*
 - *Double Screw Bar*
 - *Zirkonzahn LOC-Connector*

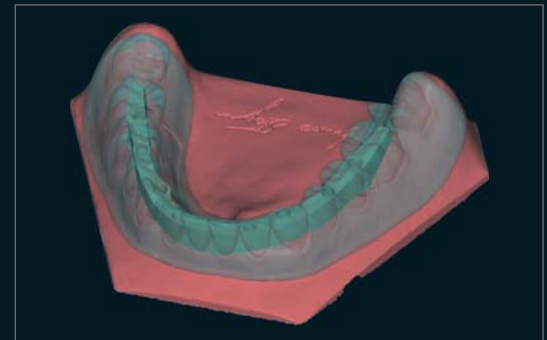
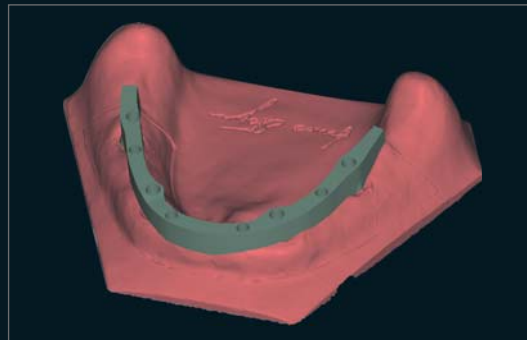
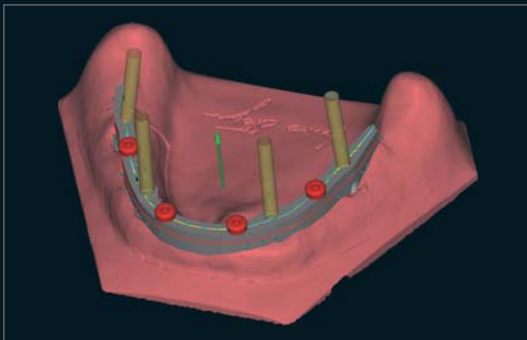



CAD/CAM VIRTUAL ARTICULATOR SOFTWARE MODULE

- *Module for jaw movement simulation in the articulator*
- *Registration of the physical articulator via the Zirkonzahn scanner*
- *All current articulators are digitally stored*
- *All movements are recreated virtually*
- *Dynamic adaptation of constructed contact points with the antagonist taking into account chewing movements*
- *Possibility of importing and using patient-specific jaw movement data (PlaneAnalyser) via an additional module*

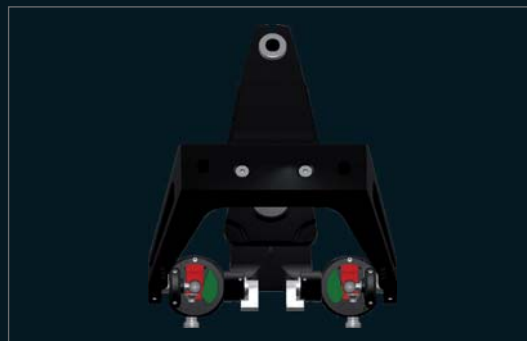
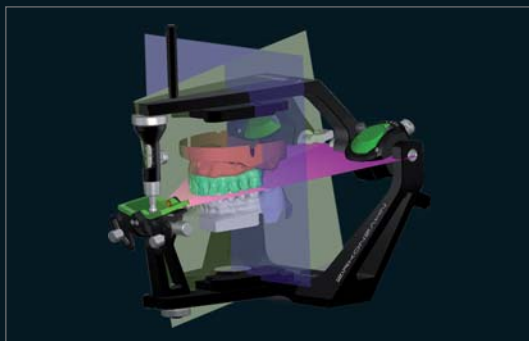

DIGITAL WORKFLOW FOR EDENTULOUS CASES

Our software supports all common implant systems and the bars design is realised in relation to the secondary structure. From single crowns to 14-unit occlusally screw-retained bridges, everything can be produced with Zirkonzahn CAD/CAM system in one's own laboratory. An example of workflow for the treatment of edentulous cases is shown below.

Case made by Dr. Francesco Mintrone, Sassuolo, Italy and MDT Antonio Corradini, Zirkonzahn Education Center Brunico, Italy

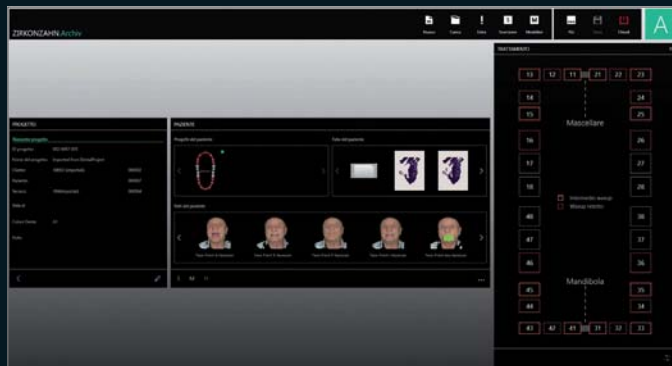

Creation of the patient case in the Zirkonzahn.Archiv software: collection and importing of all kind of data (intraoral as well as facial scans) into the software.



Digital acquisition of the gingiva: the scan is transferred into the Zirkonzahn.Scan software and matched with all other patient data available. As an alternative to the intraoral scanner, conventional acquisition methods with models and impressions can be used.

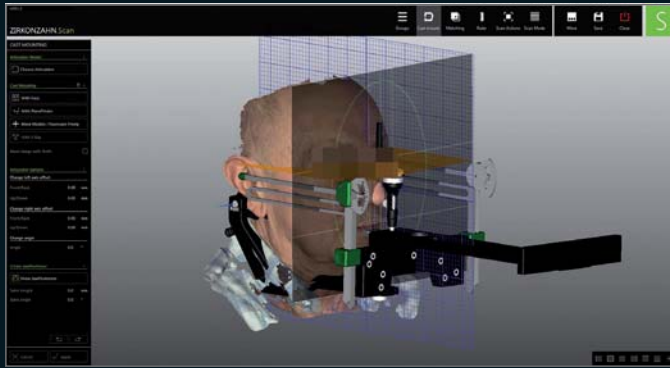

Digital acquisition of the patient's Natural Head Position and reference planes based on the PlaneSystem® (MDT, Udo Plaster): the patient's acquired data are transferred 1:1 into the Zirkonzahn.Scan software in correct position and matched with the 3D facial scans for the virtual articulation.

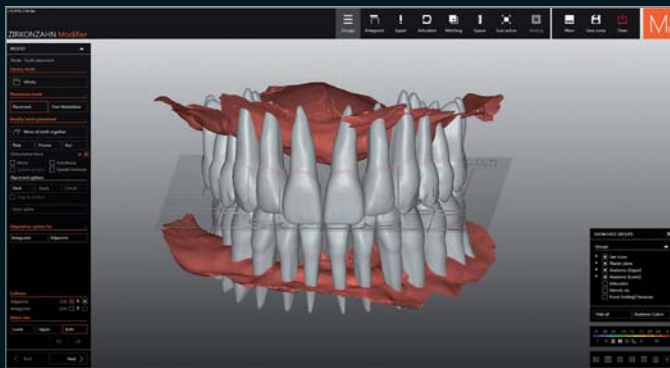

Based on the digitally recorded patient data, tooth set-ups are designed in the Zirkonzahn.Modifier software for a first evaluation of aesthetics and function. The tooth anatomies are selected from the Heroes Collection virtual tooth library.

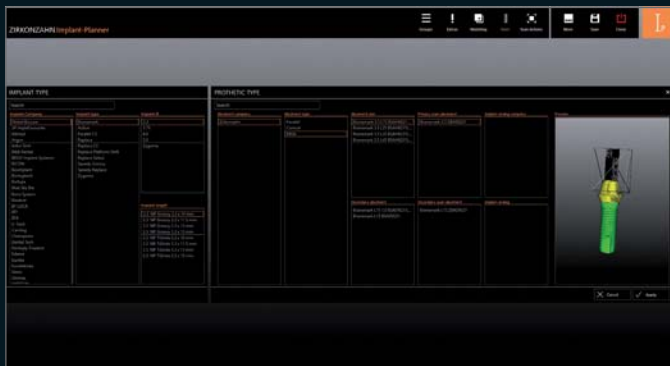

During the implant planning phase, the dentist can choose the implant systems, pins and drilling sleeves from the wide software libraries.



In the Zirkonzahn.Implant-Planner software, the implants positions are set by the dentist or proposed by the dental technician, taking into account bone density, function and aesthetics.



Only after the dentist's approval concerning the implants positions and inclinations, the dental technician can design and mill (or print with the 3D printer) the surgical guides.

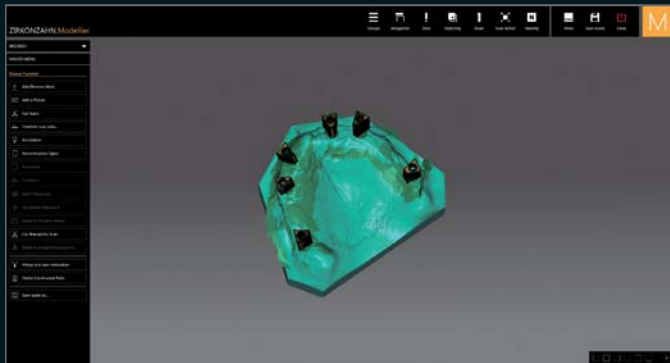

The correct implant positions are imported in the CAD software with virtual scanmarkers and the models are designed with ScanAnalog in the CAD/CAM Model Maker software module.



In order to reproduce the implant positions, the physical models equipped with ScanAnalogs can be milled or printed. The ScanAnalog and the models are then used to check the fit of the surgical guides, the prototypes and the final restoration.

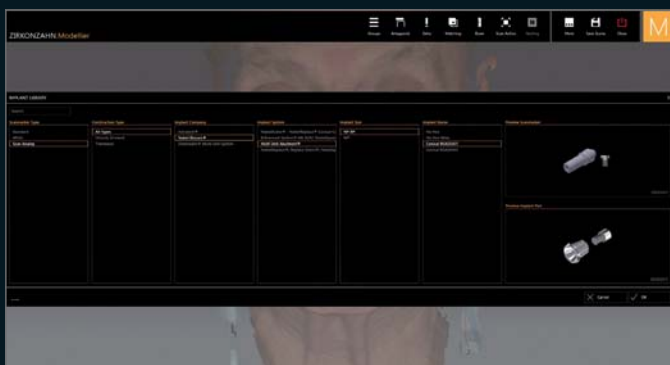

In the Zirkonzahn.Modellier software, the dental technician selects the same system and components used during the implant planning phase.

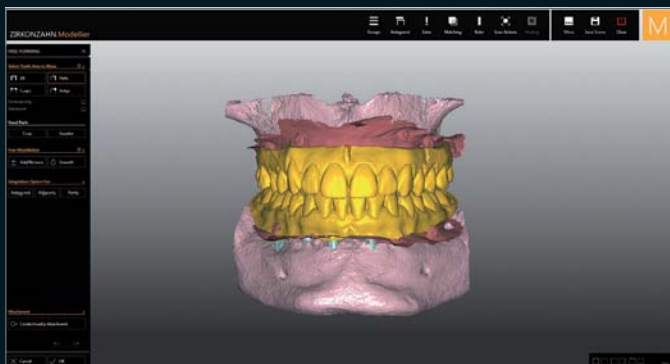

Once the resin prototypes for immediate loading are designed and milled ...



... the patient wears the prototypes until the implants have fully integrated into the bone.

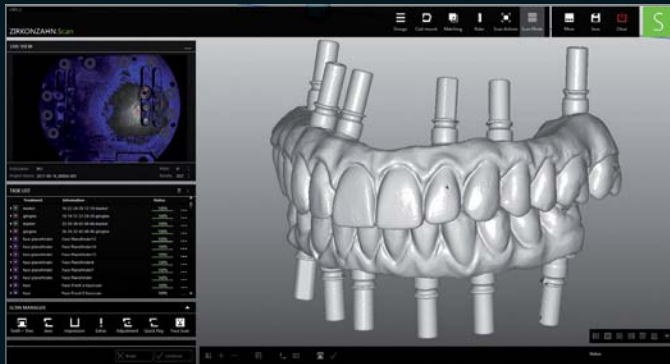

After the healing phase, the new situation is recorded by scanning the prototypes with ScanAnalog and by acquiring the gingiva impression. After matching these scan data, the temporaries for the final restorations are created. Alternatively, it is possible to use the intraoral scanner with White Scanmarkers.

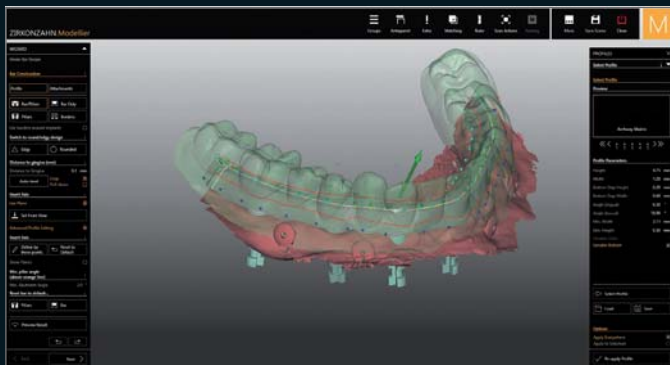

Once the temporaries have been tried on by the patient, they are scanned. Wax-ups are then created to design the final zirconia restorations and the bar is designed, milled and then anodised with the Titanium spectral-colouring Anodizer.



The final restorations in Prettau® 2 zirconia, with anodised titanium bar and bases, are then realised. The maxillary restoration is provided with threaded screw channels.



To seal the Prettau® Bridges screw channels, special resin screws are milled and applied directly in the patient's mouth.



The final Prettau® Bridges in-situ.



View the case gallery



Zirkonzahn®

IMPLANT PROSTHETICS

Zirkonzahn srl – Via An der Ahr 7 – 39030 Gais/South Tyrol

T +39 0474 066 680 – F +39 0474 066 661 – www.zirkonzahn.com – info@zirkonzahn.com



WEAA2321=

This is an international advertisement. Not all products mentioned are available in all countries. The product's area of application may differ according to the country. Please contact your Sales Team for more detailed information. All information is subject to change. Errors and omissions excepted. Version: 07/09/2022

ENGLISH